



**Product/Process Change Notification**

PCN#	Effective Date	Issue Date
2017-02-03C-01	Date Code :1710	2017/2/3
PCN Classification	Product Category	
Minor	SOP-8 Package	
Subject		
Tapping Reel Quantity Revised		
Affected Product(s)		
Product list as attachment		
Description of Change(s)		
In order to improve Production efficiency for product		
Content of Change(s)		
Tapping Leader Size 13 inch (Quantity:2.5K ) to 13 inch (Quantity:4K )		
Impact(s)		
N/A		
Attachment(s)		
Package Information. Specification		

Approval		
Issue by	Alice Lai	e-mail: alice@secosgmbh.com
Development Engineer		Alice Lai
QA Manager		Peter Yang
General Manger		Mathew Liu

For more information, please contact us directly or visit our website <http://www.secosgmbh.com>

Affected Product List

SSG05N10J	SSG4503J
SSG07N10J	SSG4822J
SSG4406J	SSG60P05J
SSG4407J	SSG7328J
SSG4410J	SSG9435J
SSG4438J	SSG9926J
SSG4459J	

**SOP-8**

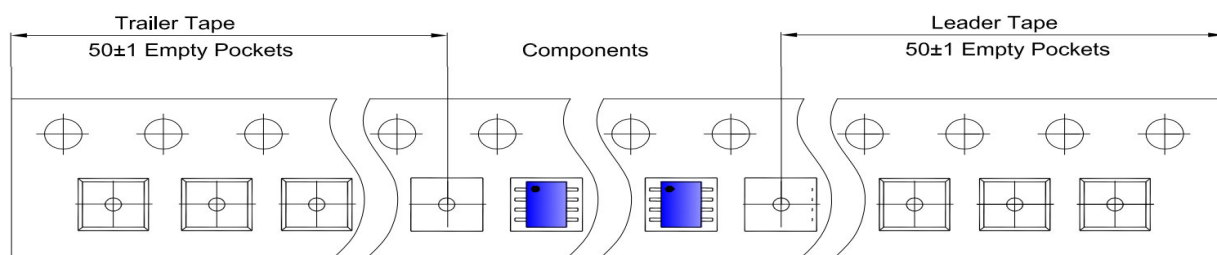
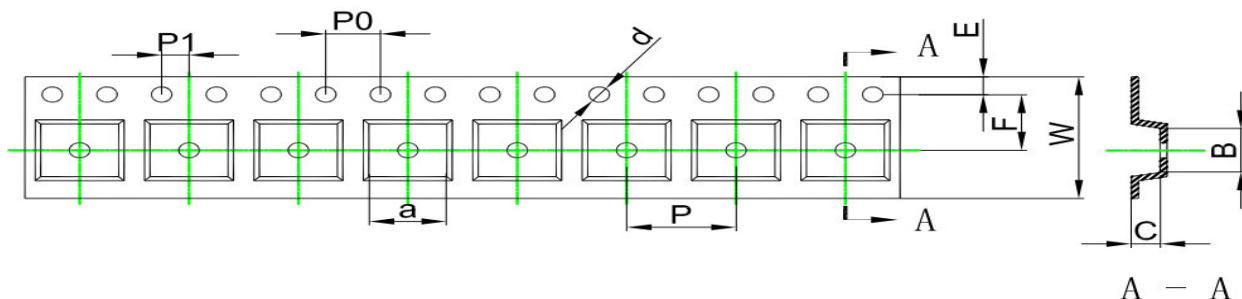

Dimensions are in millimeter

Pkg type	a	B	C	d	E	F	P0	P	P1	W
SOP8	6.40	5.40	2.10	Ø1.50	1.75	5.50	4.00	8.00	2.00	12.00

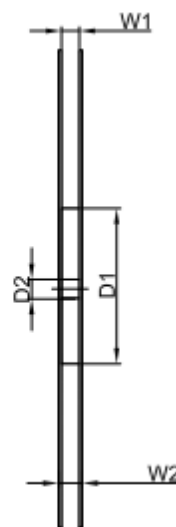
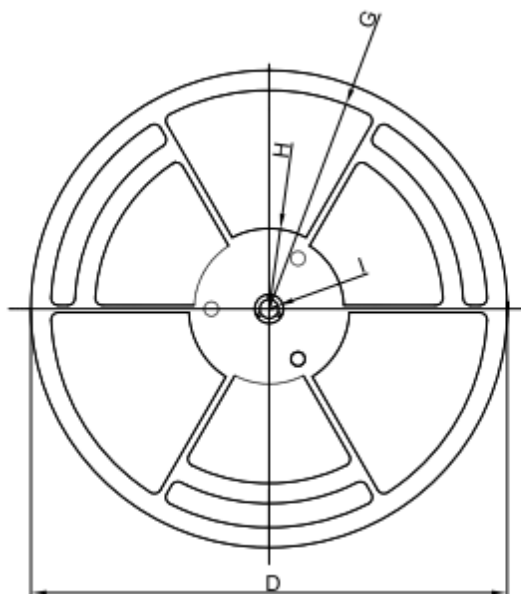

Unit: mm

Reel	D	D1	D2	G	H	I	W1	W1
13"	φ 330	100	13	R151	R56	R6.5	12.4	17.6

Reel	Reel Size	Box	Box Size (mm)	Carton	Carton Size (mm)	G.W. (kg)
4,000 Pcs	13 inch	8,000Pcs	350 x 350 x 40	64,000 Pcs	350 x 350 x 350	1.6 (Approximately)