

RoHS Compliant Product  
A suffix of "-C" specifies halogen & lead-free

## DESCRIPTION

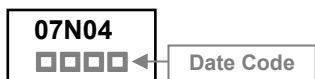
The SSG07N04-C is the highest performance trench N-ch MOSFETs with extreme high cell density, which provide excellent  $R_{DS(ON)}$  and gate charge for most of the synchronous buck converter applications.

The SSG07N04-C meet the RoHS and Green Product requirement, with full function reliability approved.

## FEATURES

- Advanced high cell density Trench technology
- Super Low Gate Charge
- Green Device Available

## MARKING CODE



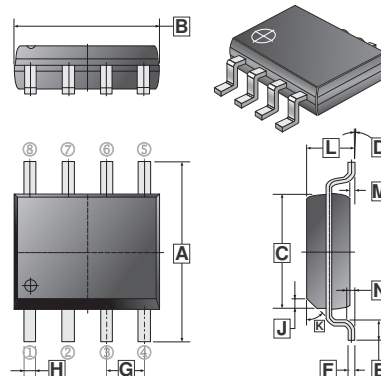
## PACKAGE INFORMATION

Package	MPQ	Leader Size
SOP-8	2.5K	13' inch

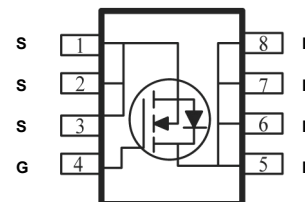
## ORDER INFORMATION

Part Number	Type
SSG07N04-C	Lead (Pb)-free and Halogen-free

## SOP-8



REF.	Millimeter		REF.	Millimeter	
	Min.	Max.		Min.	Max.
A	5.79	6.20	H	0.33	0.51
B	4.70	5.11	J	0.375 REF.	
C	3.80	4.00	K	45° REF.	
D	0°	8°	L	1.3	1.752
E	0.40	1.27	M	0	0.25
F	0.10	0.25	N	0.25 REF.	
G	1.27 TYP.				



## ABSOLUTE MAXIMUM RATINGS ( $T_A=25^\circ\text{C}$ unless otherwise specified)

Parameter	Symbol	Ratings	Unit
Drain-Source Voltage	$V_{DS}$	40	V
Gate-Source Voltage	$V_{GS}$	$\pm 20$	V
Continuous Drain Current @ $V_{GS}=10\text{V}$ <sup>1</sup>	$I_D$	$T_A=25^\circ\text{C}$	7
		$T_A=80^\circ\text{C}$	5.2
Pulsed Drain Current <sup>4</sup>	$I_{DM}$	30	A
Power Dissipation <sup>3</sup>	$P_D$	1.5	W
Operating Junction & Storage Temperature Range	$T_J, T_{STG}$	-55~150	$^\circ\text{C}$
<b>Thermal Resistance Ratings</b>			
Thermal Resistance Junction-ambient <sup>1</sup>	$R_{\theta JA}$	85	$^\circ\text{C} / \text{W}$
Thermal Resistance Junction-ambient <sup>2</sup>		135	
Thermal Resistance Junction-Case <sup>1</sup>	$R_{\theta JC}$	50	

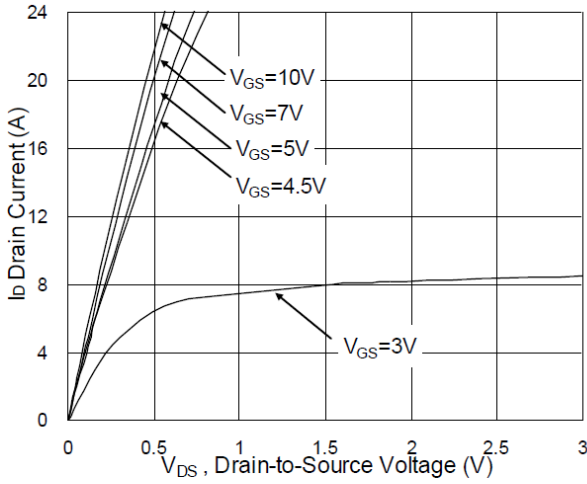
**ELECTRICAL CHARACTERISTICS** ( $T_J=25^\circ\text{C}$  unless otherwise specified)

Parameter	Symbol	Min.	Typ.	Max.	Unit	Test condition
Drain-Source Breakdown Voltage	$BV_{DSS}$	40	-	-	V	$V_{GS}=0V, I_D=250\mu A$
Gate-Threshold Voltage	$V_{GS(th)}$	1	-	2.5	V	$V_{DS}=V_{GS}, I_D=250\mu A$
Forward Transfer conductance	$g_{fs}$	-	14	-	S	$V_{DS}=5V, I_D=5A$
Gate-Body Leakage	$I_{GSS}$	-	-	$\pm 100$	nA	$V_{GS}=\pm 20V$
Zero Gate Voltage Drain Current	$I_{DSS}$	-	-	1	$\mu A$	$V_{DS}=32V, V_{GS}=0, T_J=25^\circ C$
		-	-	5		$V_{DS}=32V, V_{GS}=0, T_J=55^\circ C$
Drain-Source On-Resistance <sup>4</sup>	$R_{DS(ON)}$	-	-	30	m $\Omega$	$V_{GS}=10V, I_D=6A$
		-	-	40		$V_{GS}=4.5V, I_D=4A$
Total Gate Charge	$Q_g$	-	5.5	-	nC	$I_D=6A$ $V_{DS}=20V$ $V_{GS}=4.5V$
Gate-Source Charge	$Q_{gs}$	-	1.25	-		
Gate-Drain ("Miller") Charge	$Q_{gd}$	-	2.5	-		
Turn-On Delay Time	$T_{d(on)}$	-	8.9	-	nS	$V_{DS}=20V$ $I_D=1A$ $V_{GS}=10V$ $R_G=3.3\Omega$
Rise Time	$T_r$	-	2.2	-		
Turn-Off Delay Time	$T_{d(off)}$	-	41	-		
Fall Time	$T_f$	-	2.7	-		
Input Capacitance	$C_{iss}$	-	593	-	pF	$V_{GS}=0V$ $V_{DS}=15V$ $f=1.0MHz$
Output Capacitance	$C_{oss}$	-	76	-		
Reverse Transfer Capacitance	$C_{rss}$	-	56	-		
<b>Source-Drain Diode</b>						
Forward On Voltage <sup>4</sup>	$V_{SD}$	-	-	1.2	V	$I_S=1A, V_{GS}=0V$
Continuous Source Current <sup>1</sup>	$I_S$	-	-	7	A	
Pulsed Source Current <sup>3,4</sup>	$I_{SM}$	-	-	30	A	

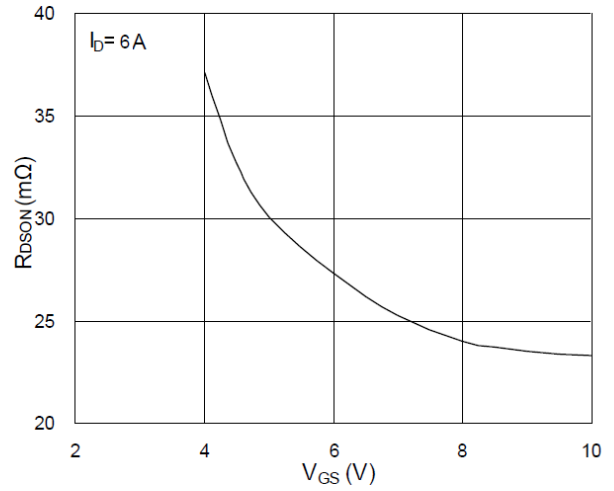
Notes:

1. Surface mounted on a 1 inch<sup>2</sup> FR-4 board with 2OZ copper.
2. When mounted on Min. copper pad.
3. The power dissipation is limited by 150°C junction temperature.
4. The data tested by pulsed, pulse width  $\leq 300\mu s$ , duty cycle  $\leq 2\%$

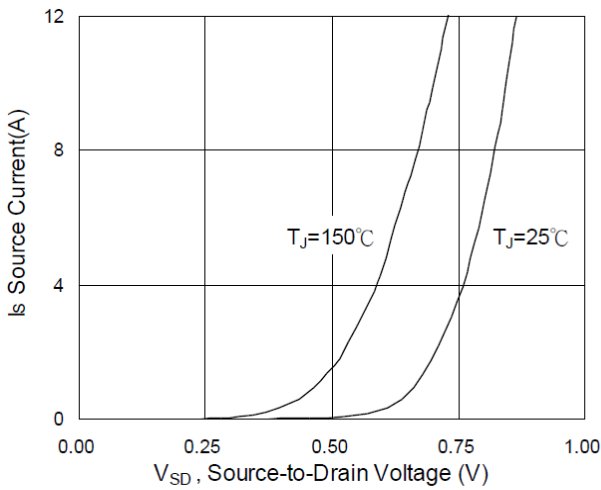
**CHARACTERISTICS CURVE**



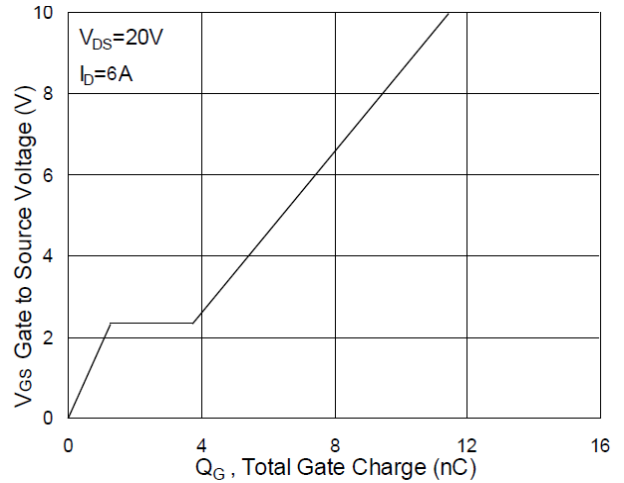
**Fig.1 Typical Output Characteristics**



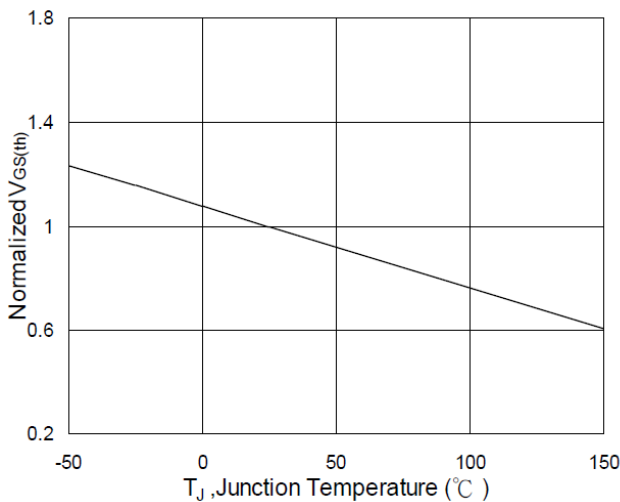
**Fig.2 On-Resistance vs. G-S Voltage**



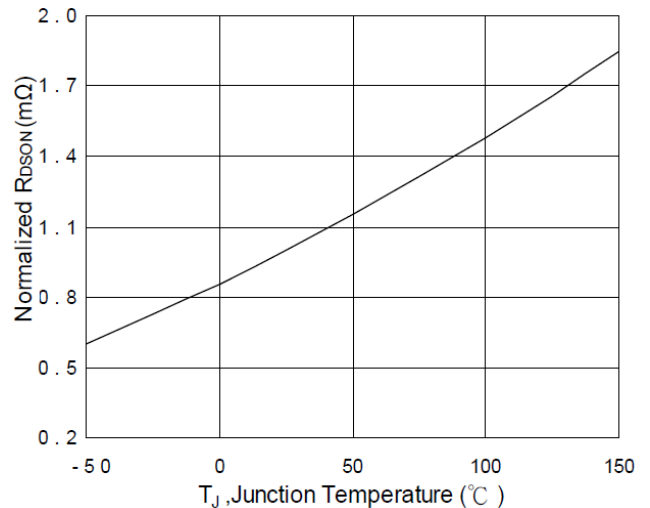
**Fig.3 Forward Characteristics of Reverse**



**Fig.4 Gate-Charge Characteristics**

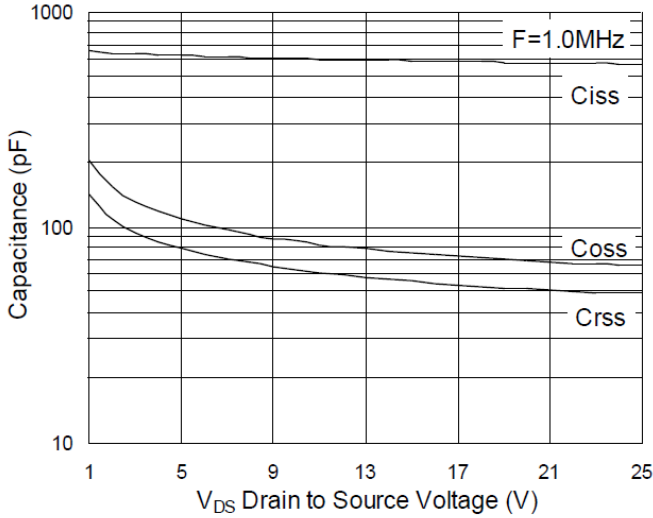


**Fig.5 Normalized  $V_{GS(th)}$  vs.  $T_J$**

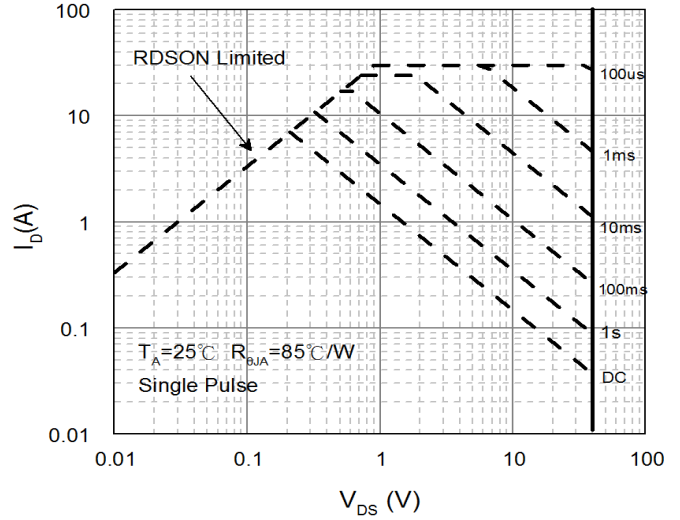


**Fig.6 Normalized  $R_{DS(on)}$  vs.  $T_J$**

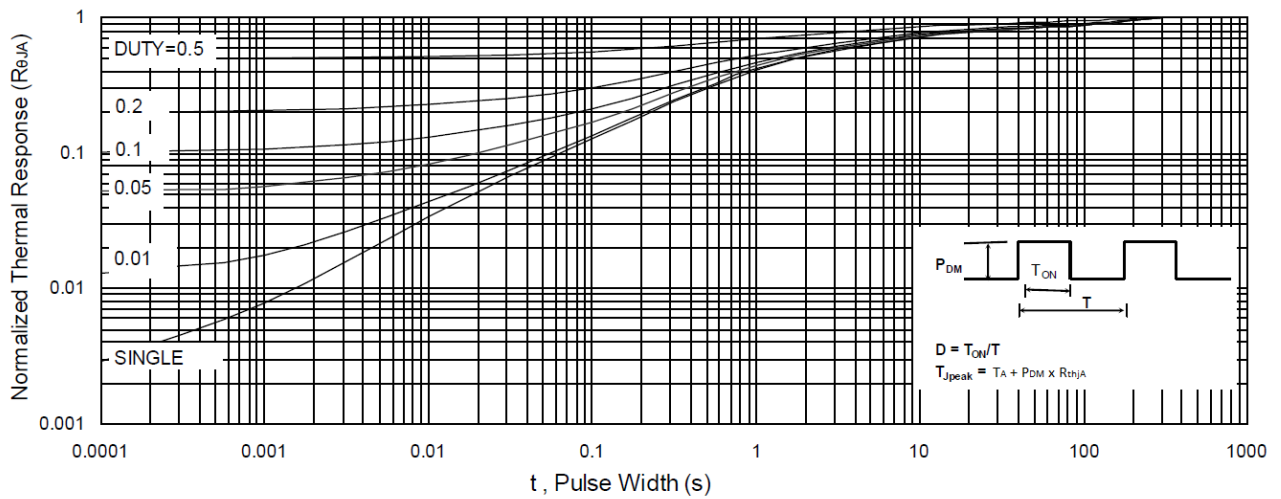
**CHARACTERISTICS CURVE**



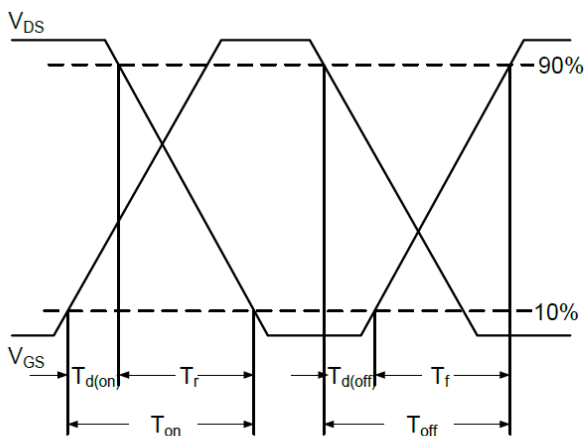
**Fig.7 Capacitance**



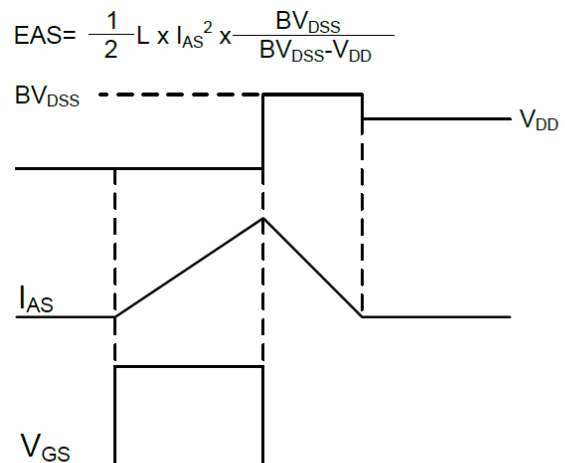
**Fig.8 Safe Operating Area**



**Fig.9 Normalized Maximum Transient Thermal Impedance**



**Fig.10 Switching Time Waveform**



**Fig.11 Unclamped Inductive Switching Waveform**