

RoHS Compliant Product
A suffix of "-C" specifies halogen & lead-free

FEATURES

- Low Input Capacitance
- Fast Switching Speed
- Low Input / Output Leakage
- Voltage Controlled Small Signal Switch
- Moisture Sensitivity Level 1
- Epoxy Meets UL 94 V-0 Flammability Rating
- ESD Protected up to 2kV (HBM)

SOT-723



MARKING

72

PACKAGE INFORMATION

Package	MPQ	Leader Size
SOT-723	8K	7 inch

ORDER INFORMATION

Part Number	Type
SSN72K-C	Lead (Pb)-free and Halogen-free

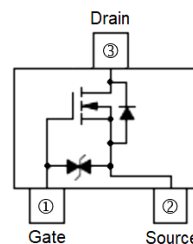

MAXIMUM RATINGS ($T_A=25^{\circ}\text{C}$ unless otherwise specified)

Parameter	Symbol	Ratings	Unit
Drain-Source Voltage	V_{DS}	60	V
Gate-Source Voltage	V_{GS}	± 20	V
Continuous Drain Current @ $V_{GS}=10\text{V}$	I_D	$T_A=25^{\circ}\text{C}$	0.3
		$T_A=100^{\circ}\text{C}$	0.2
Pulsed Drain Current ¹	I_{DM}	0.9	A
Total Power Dissipation ²	P_D	$T_A=25^{\circ}\text{C}$	0.34
		$T_A=100^{\circ}\text{C}$	0.13
Operating Junction & Storage Temperature Range	T_J, T_{STG}	150, -55~150	$^{\circ}\text{C}$
Thermal Data			
Thermal Resistance Junction-Ambient ³	$R_{\theta JA}$	360	$^{\circ}\text{C/W}$

ELECTRICAL CHARACTERISTICS (T_J=25°C unless otherwise specified)

Parameter	Symbol	Min.	Typ.	Max.	Unit	Test Conditions
Drain-Source Breakdown Voltage	V _{(BR)DSS}	60	-	-	V	V _{GS} =0, I _D =250μA
Gate Threshold Voltage	V _{GS(th)}	1	-	2.5	V	V _{DS} =V _{GS} , I _D =250μA
Gate-Body Leakage Current	I _{GSS}	-	-	±10	μA	V _{DS} =0, V _{GS} =±20V
Zero Gate Voltage Drain Current	I _{DSS}	-	-	1	μA	V _{DS} =60V, V _{GS} =0
		-	-	100		V _{DS} =60V, V _{GS} =0, T _J =125°C
Drain-Source On-Resistance	R _{DS(ON)}	-	1.8	2.5	Ω	V _{GS} =10V, I _D =0.3A
		-	2	3		V _{GS} =4.5V, I _D =0.2A
Gate Resistance	R _g	-	130	-	Ω	f=1MHz
Total Gate Charge	Q _g	-	1.22	-	nC	I _D =0.3A V _{DS} =30V V _{GS} =10V
Gate-Source Charge	Q _{gs}	-	0.5	-		
Gate-Drain Charge	Q _{gd}	-	0.18	-		
Turn-on Delay Time	T _{d(on)}	-	7	-	nS	V _{DD} =30V I _D =0.3A V _{GS} =10V R _{GEN} =50Ω
Rise Time	T _r	-	19	-		
Turn-off Delay Time	T _{d(off)}	-	20	-		
Fall Time	T _f	-	84	-		
Input Capacitance	C _{iss}	-	13	-	pF	V _{DS} =30V V _{GS} =0 f=1MHz
Output Capacitance	C _{oss}	-	5	-		
Reverse Transfer Capacitance	C _{rss}	-	1	-		
Source-Drain Diode						
Diode Forward Voltage	V _{SD}	-	0.9	1.2	V	I _S =0.3A, V _{GS} =0V
Continuous Source Current	I _S	-	-	0.3	A	
Reverse Recovery Time	t _{rr}	-	16	-	nS	I _F =0.3A, dI/dt=100A/μs
Reverse Recovery Charge	Q _{rr}	-	3.6	-	nC	

Notes:

1. Repetitive rating; pulse width limited by max. junction temperature.
2. P_D is based on max. junction temperature, using junction-case thermal resistance.
3. The value of R_{θJA} is measured with the device mounted on 1 in² FR-4 board with 2oz. Copper, in the still air environment with T_A=25°C. The maximum allowed junction temperature of 150°C.

CHARACTERISTIC CURVES

Figure 1. Output Characteristics

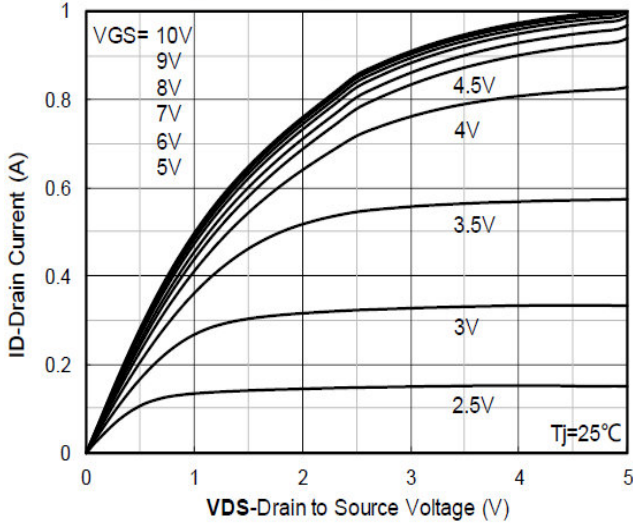

Figure 2. Transfer Characteristics

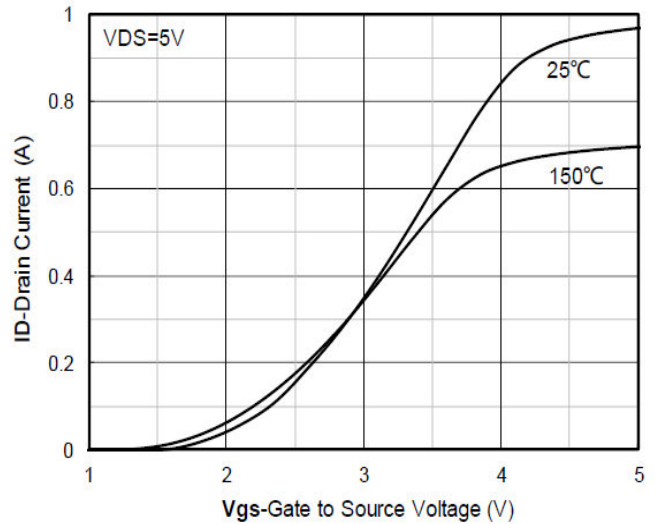

Figure 3. Capacitance Characteristics

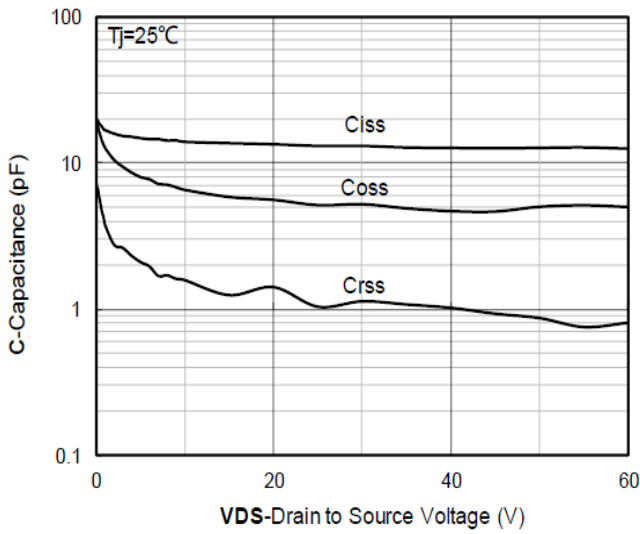

Figure 4. Gate Charge

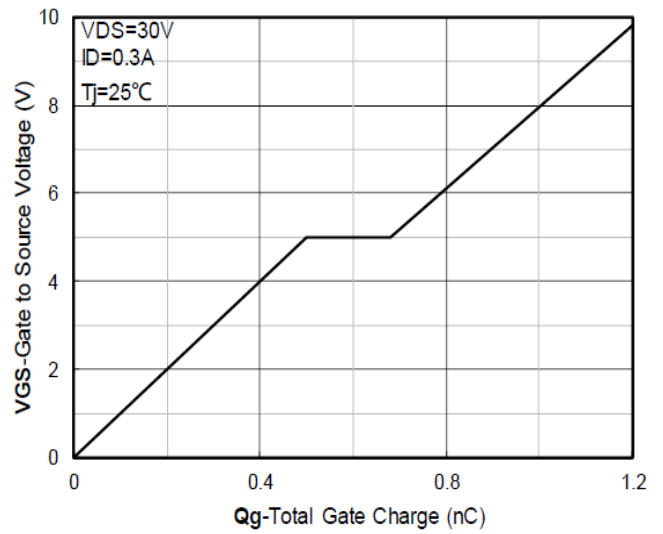

Figure 5. On-Resistance vs Gate to Source Voltage

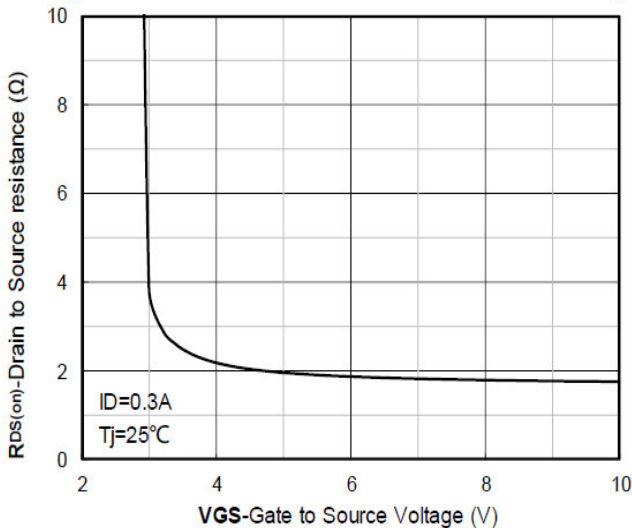
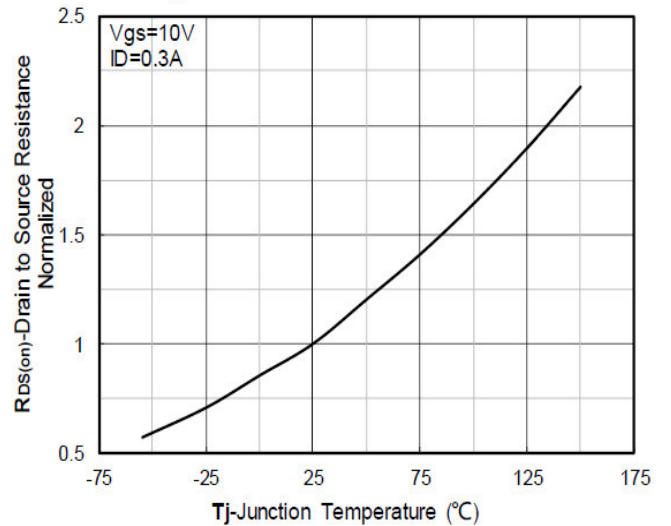

Figure 6. Normalized On-Resistance



CHARACTERISTIC CURVES

Figure 7. $R_{DS(on)}$ VS Drain Current

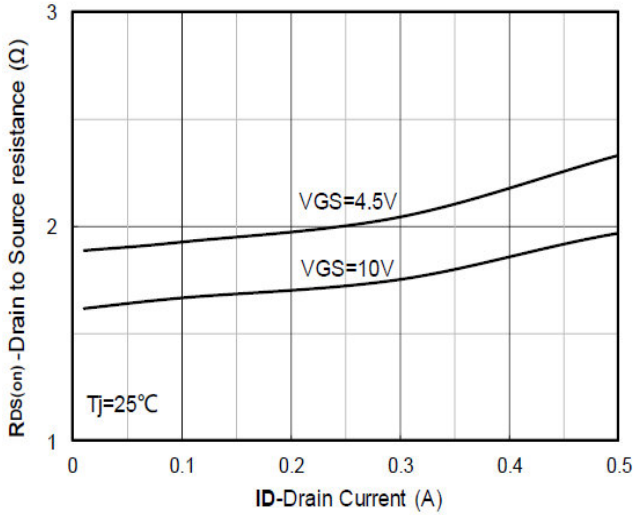

Figure 8. Forward characteristics of reverse diode

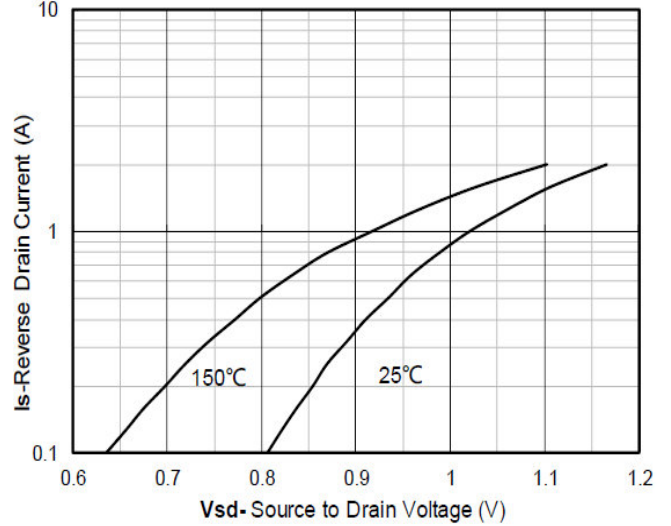

Figure 9. Normalized breakdown voltage

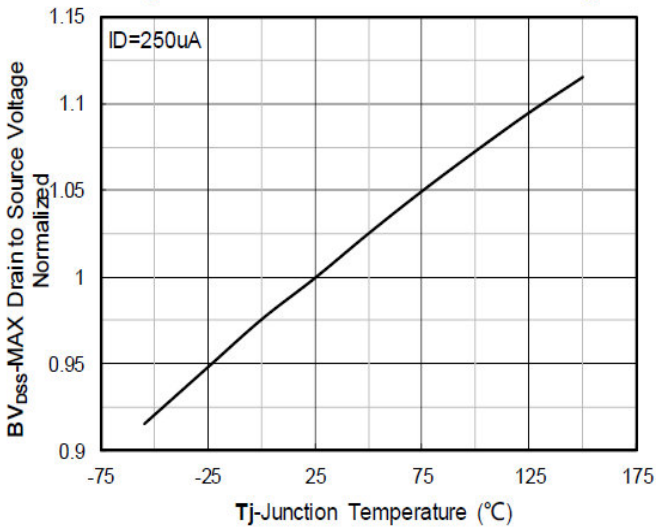

Figure 10. Normalized Threshold voltage

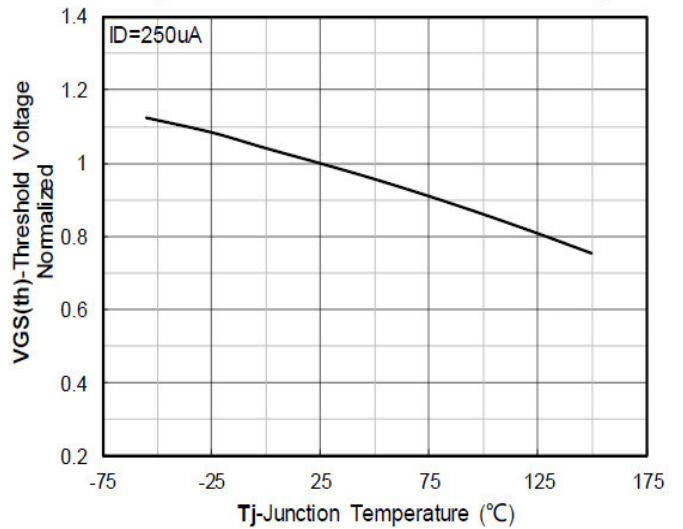

Figure 11. Current dissipation

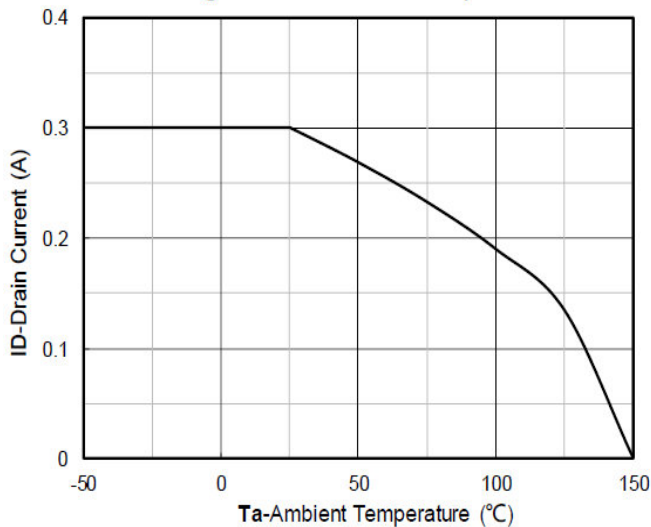
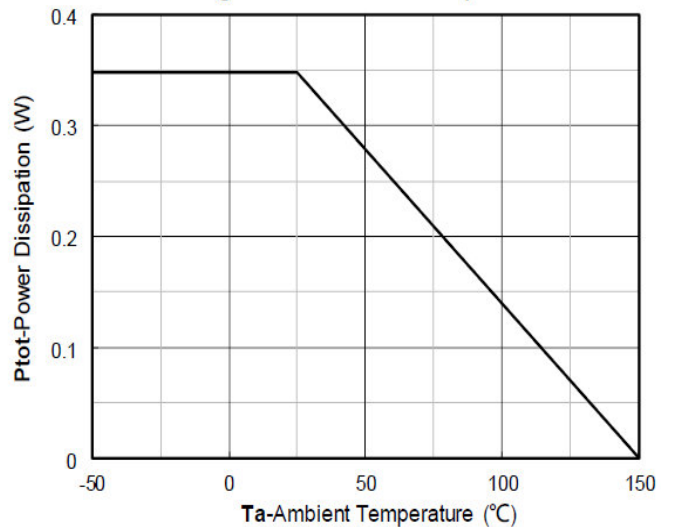

Figure 12. Power dissipation



CHARACTERISTIC CURVES

Figure 13. Maximum Transient Thermal Impedance

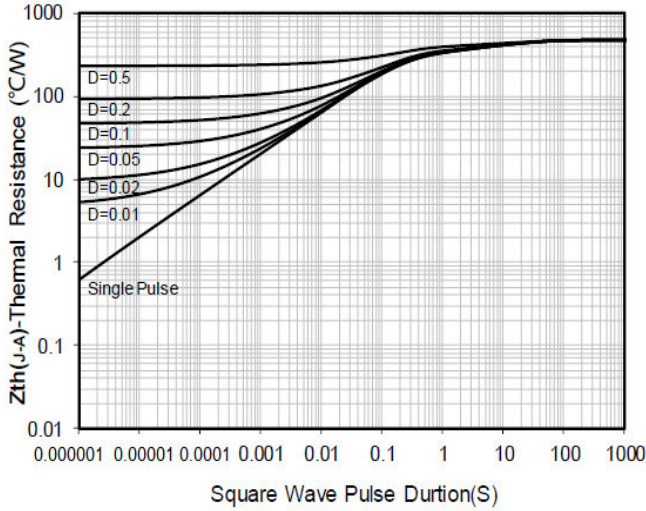

Figure 14. Safe Operation Area

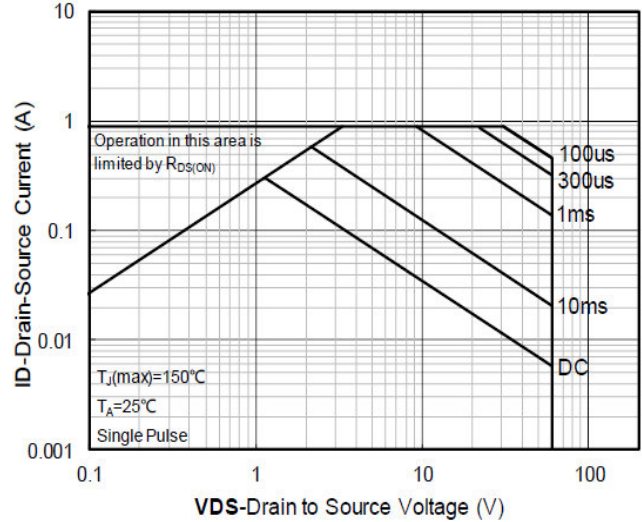
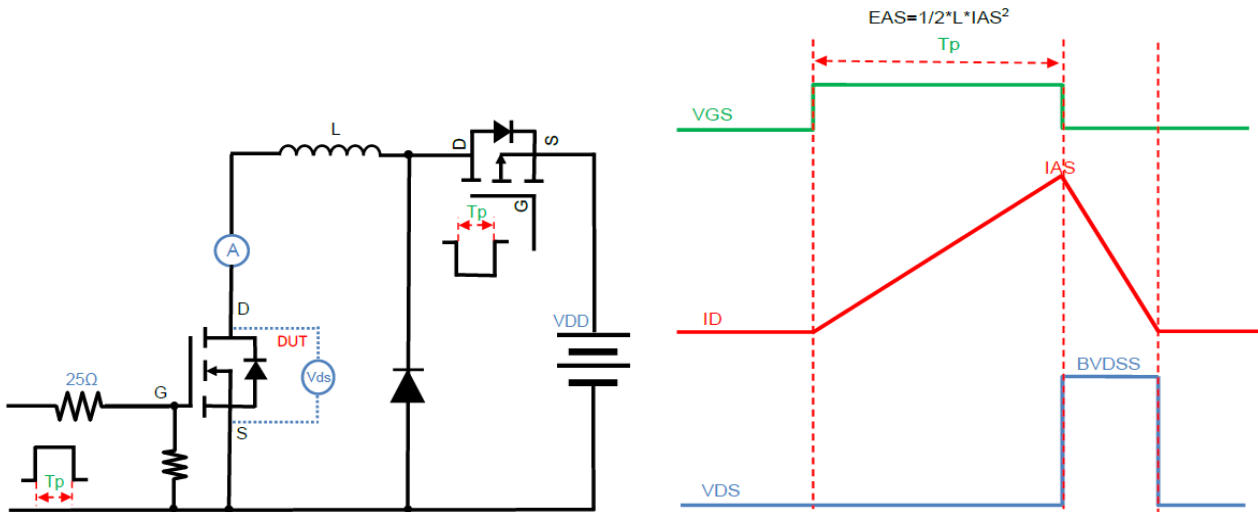
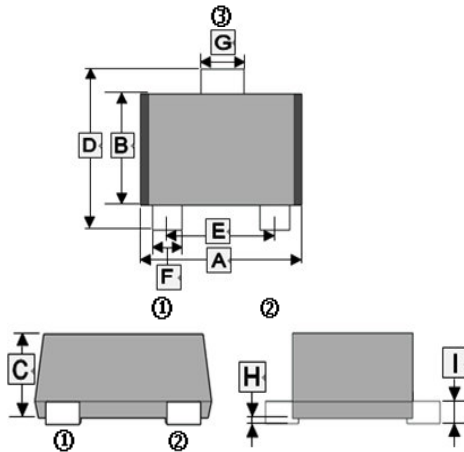

Figure 15. Unclamped Inductive Switching (UIS) Test Circuit & Waveform



PACKAGE OUTLINE DIMENSIONS

SOT-723



REF.	Millimeter	
	Min.	Max.
A	1.15	1.25
B	0.75	0.85
C	-	0.55
D	1.15	1.25
E	0.80 TYP.	
F	0.15	0.27
G	0.25	0.37
H	0.025 TYP.	
I	-	0.20

MOUNTING PAD LAYOUT

SOT-723

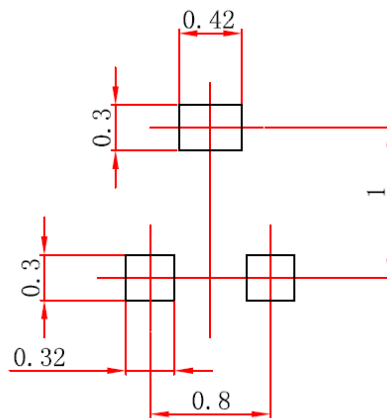

*Dimensions in millimeters