

RoHS compliant product  
A suffix of "-C" specifies halogen free

## FEATURES

- Zero Reverse Recovery Current
- Zero Forward Recovery Voltage
- Positive Temperature Coefficient on  $V_F$
- Temperature-independent Switching
- 175°C Operating Junction Temperature

TO-252

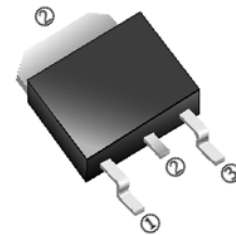

## MECHANICAL DATA

- Case: Molded Plastic
- Epoxy: UL94V-0 Rate Flame Retardant
- Lead: Lead Solderable per MIL-STD-202 Method 208 Guaranteed
- Polarity: As Marked
- Mounting Position: Any

## APPLICATIONS

- Switch Mode Power Supplies
- Power Factor Correction
- Motor Drive, PV Inverter, Wind Power Station

## ORDER INFORMATION

Part Number	Type
SIC06X65DS1-C	Lead (Pb)-free and Halogen-free

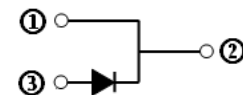

## MAXIMUM RATINGS (Rating 25°C Case temperature unless otherwise)

Parameter	Symbol	Rating	Unit
Repetitive Peak Reverse Voltage	$V_{RRM}$	650	V
Surge Peak Reverse Voltage	$V_{RSM}$	650	V
DC Blocking Voltage	$V_{DC}$	650	V
Forward Current	$I_F$	$T_C \leq 25^\circ\text{C}$	19
		$T_C \leq 135^\circ\text{C}$	9
		$T_C \leq 155^\circ\text{C}$	6
Non-Repetitive Peak Forward Surge Current @8.3ms half sine-wave	$I_{FSM}$	60	A
Power Dissipation	$T_C = 25^\circ\text{C}$	$P_D$	83.3 W
Operating Junction & Storage Temperature	$T_J, T_{STG}$	-55~175	°C
<b>Thermal Resistance Ratings</b>			
Typical Thermal Resistance Junction-Ambient	$R_{\theta JA}$	80	°C/W
Typical Thermal Resistance Junction-Case	$R_{\theta JC}$	1.8	

## ELECTRICAL CHARACTERISTICS

Parameter	Symbol	Typ.	Max.	Unit	Test Conditions
Forward Voltage	$V_F$	1.5	1.65	V	$I_F = 6A, T_J = 25^\circ\text{C}$
		1.75	2.3		$I_F = 6A, T_J = 175^\circ\text{C}$
Reverse Current	$I_R$	1	20	$\mu\text{A}$	$V_R = 650V, T_J = 25^\circ\text{C}$
		5	100		$V_R = 650V, T_J = 175^\circ\text{C}$
Junction Capacitance	$C_J$	300	-	pF	$V_R = 0V, T_J = 25^\circ\text{C}, f = 1\text{MHz}$
		34	-		$V_R = 200V, T_J = 25^\circ\text{C}, f = 1\text{MHz}$
		30	-		$V_R = 400V, T_J = 25^\circ\text{C}, f = 1\text{MHz}$
Total Capacitive Charge	$Q_C$	18	-	nC	$V_R = 650V, I_F = 6A, T_J = 25^\circ\text{C}, dI/dt = 200A/\mu\text{s}$

**CHARACTERISTIC CURVES**

Figure 1. Forward Characteristics

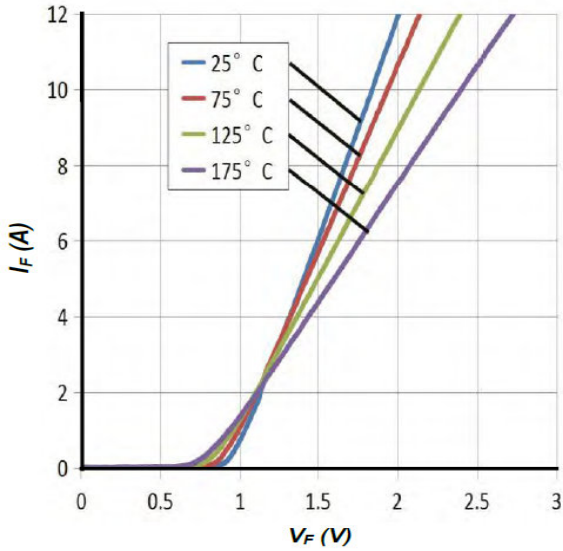

Figure 2. Reverse Characteristics

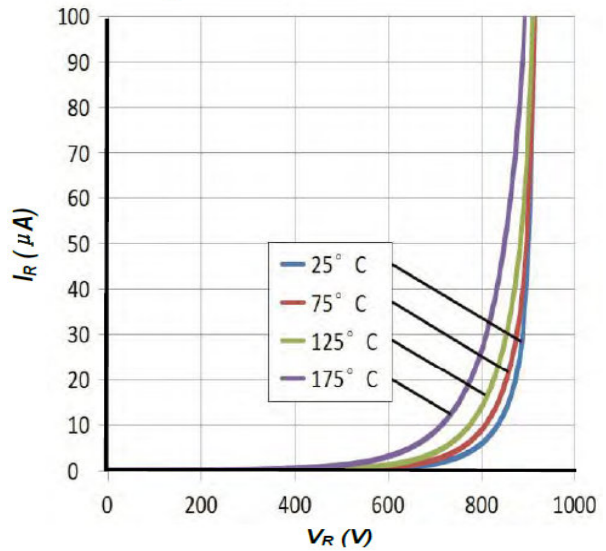

Figure 3. Power Derating

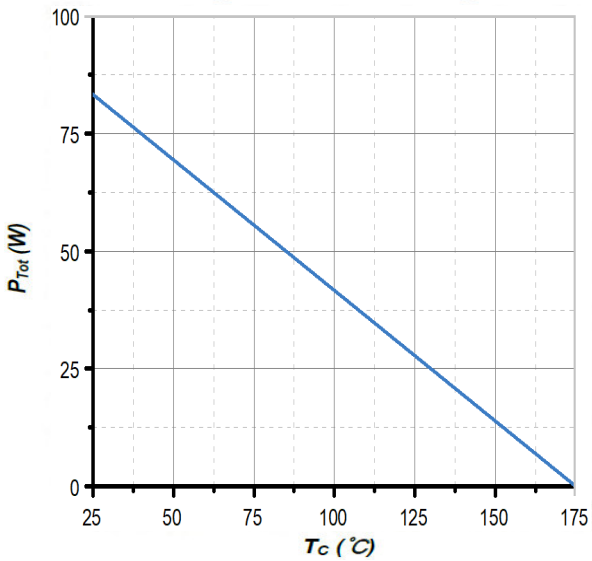

Figure 4. Total Capacitive Charge vs. Reverse Voltage

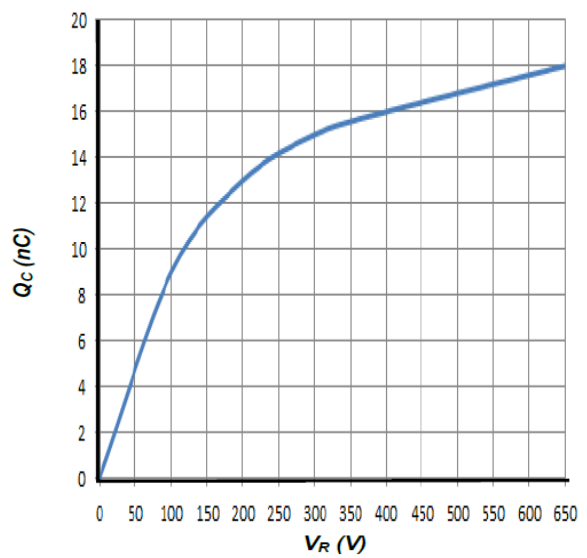
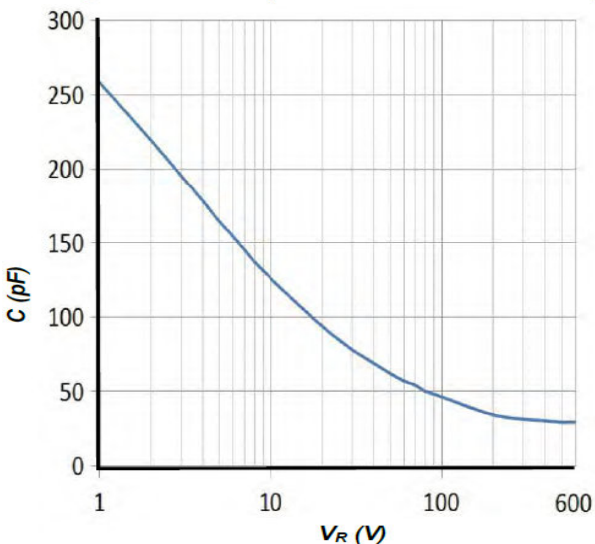
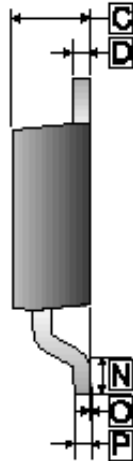
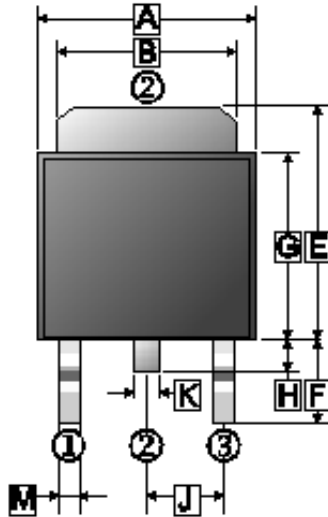

Figure 5. Total Capacitance vs. Reverse Voltage



**PACKAGE OUTLINE DIMENSIONS**

TO-252



REF.	Millimeter	
	Min.	Max.
A	6.30	6.90
B	4.95	5.53
C	2.10	2.50
D	0.40	0.90
E	6.00	7.70
F	2.90 REF.	
G	5.40	6.40
H	0.60	1.20
J	2.30 REF.	
K	0.89 REF.	
M	0.45	1.14
N	1.55 TYP.	
O	0	0.15
P	0.58 REF.	

**MOUNTING PAD LAYOUT**

TO-252

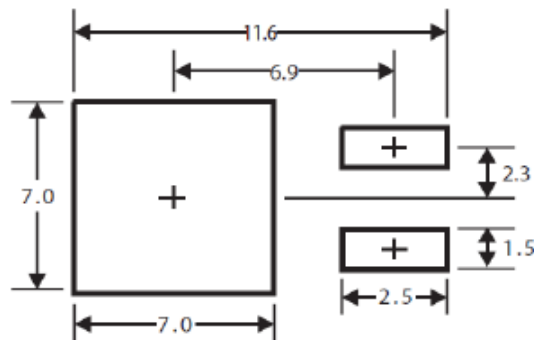

\*Dimensions in millimeters