

RoHS Compliant Product
A suffix of "-C" specifies halogen and lead free

FEATURES

- I_C Max.= -500 mA
- Low $V_{CE(sat)}$. Ideal for low-voltage operation.

CLASSIFICATION OF h_{FE}

Product-Rank	2SA1036-P	2SA1036-Q	2SA1036-R
Range	82~180	120~270	180~390
Marking	HP	HQ	HR

SOT-23

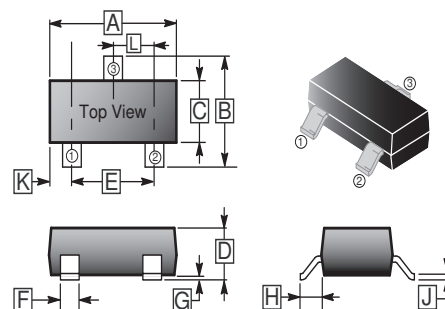

PACKAGE INFORMATION

Package	MPQ	LeaderSize
SOT-23	3K	7' inch

REF.	Millimeter		REF.	Millimeter	
	Min.	Max.		Min.	Max.
A	2.80	3.04	G	0.09	0.18
B	2.10	2.55	H	0.45	0.60
C	1.20	1.40	J	0.08	0.177
D	0.89	1.15	K	0.6 REF.	
E	1.78	2.04	L	0.89	1.02
F	0.30	0.50			

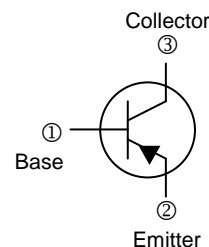

ABSOLUTE MAXIMUM RATINGS ($T_A = 25^\circ\text{C}$ unless otherwise specified)

Parameter	Symbol	Ratings	Unit
Collector to Base Voltage	V_{CBO}	-40	V
Collector to Emitter Voltage	V_{CEO}	-32	V
Emitter to Base Voltage	V_{EBO}	-5	V
Collector Current	I_C	-500	mA
Total Power Dissipation	P_D	150	mW
Junction & Storage Temperature	T_J, T_{STG}	150, -55 ~ 150	$^\circ\text{C}$

ELECTRICAL CHARACTERISTICS ($T_A = 25^\circ\text{C}$ unless otherwise specified)

Parameter	Symbol	Min.	Typ.	Max.	Unit	Test Conditions
Collector-base breakdown voltage	$V_{(BR)CBO}$	-40	-	-	V	$I_C = -100\mu\text{A}, I_E = 0$
Collector-emitter breakdown voltage	$V_{(BR)CEO}$	-32	-	-	V	$I_C = -1\text{mA}, I_B = 0$
Emitter-base breakdown voltage	$V_{(BR)EBO}$	-5	-	-	V	$I_E = -100\mu\text{A}, I_C = 0$
Collector cut-off current	I_{CBO}	-	-	-1	μA	$V_{CB} = -20\text{V}, I_E = 0$
Emitter cut-off current	I_{EBO}	-	-	-1	μA	$V_{EB} = -4\text{V}, I_C = 0$
Collector-emitter saturation voltage	$V_{CE(sat)}$	-	-	-0.4	V	$I_C = -100\text{mA}, I_B = -10\text{mA}$
DC current gain	h_{FE}	82	-	390		$V_{CE} = -3\text{V}, I_C = -10\text{mA}$
Transition frequency	f_T	-	200	-	MHz	$V_{CE} = -5\text{V}, I_C = -20\text{mA}, f = 100\text{MHz}$
Collector output capacitance	C_{OB}	-	7	-	pF	$V_{CB} = -10\text{V}, I_E = 0, f = 1\text{MHz}$

CHARACTERISTIC CURVES

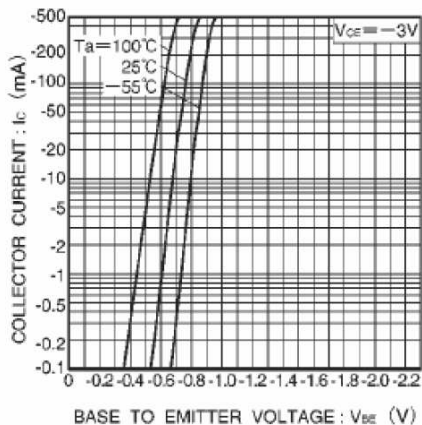

Fig.1 Grounded emitter propagation

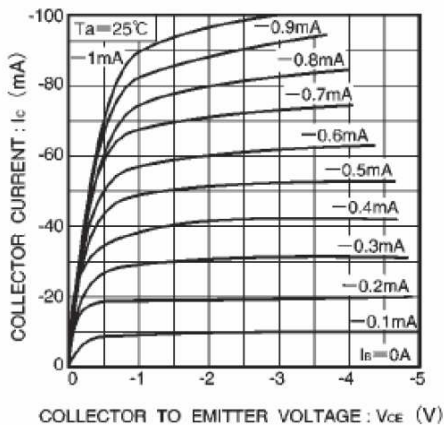

Fig.2 Grounded emitter output characteristics (I)

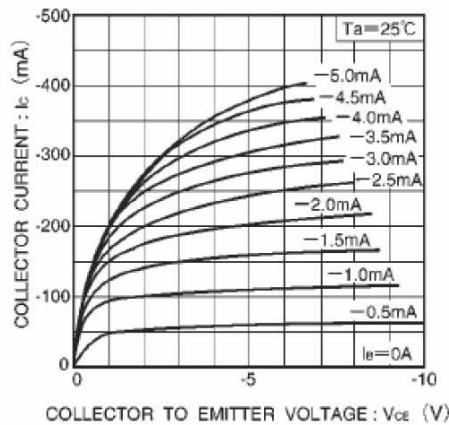

Fig.3 Grounded emitter output characteristics (II)

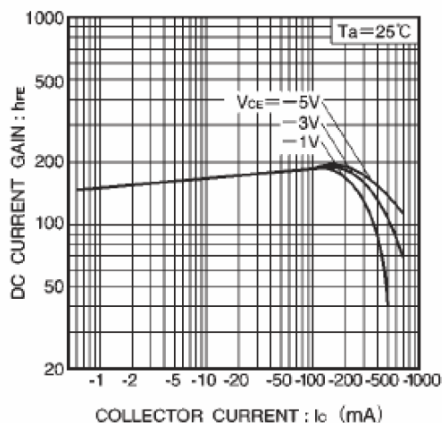

Fig.4 DC current gain vs. collector current (I)

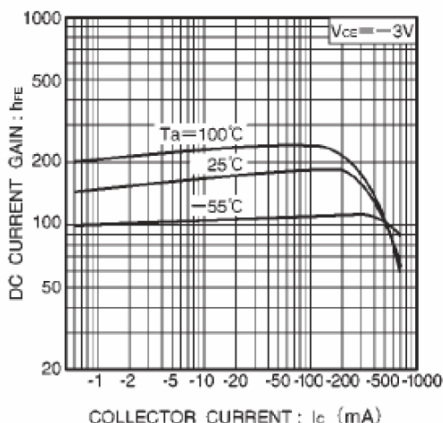

Fig.5 DC current gain vs. collector current (II)

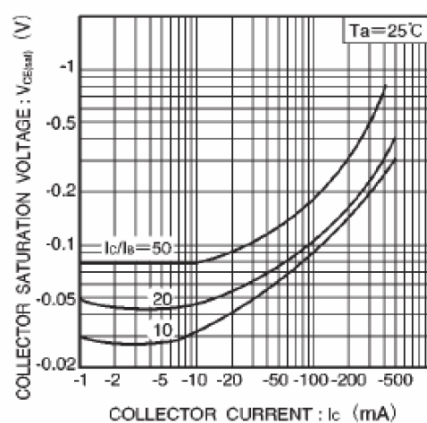

Fig.6 Collector-emitter saturation voltage vs. collector current (I)

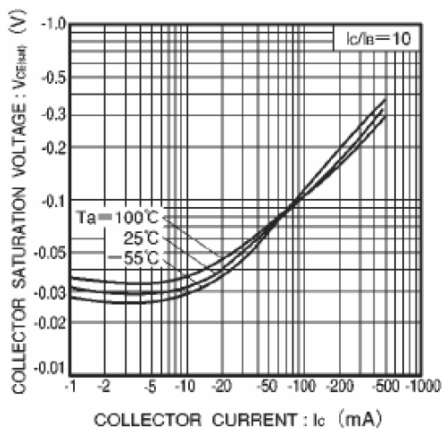

Fig.7 Collector-emitter saturation voltage vs. collector current (II)

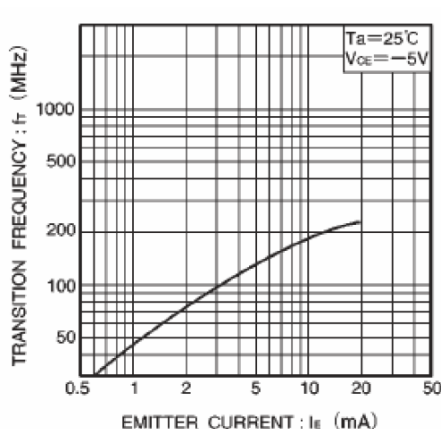

Fig.8 Gain bandwidth product vs. emitter current

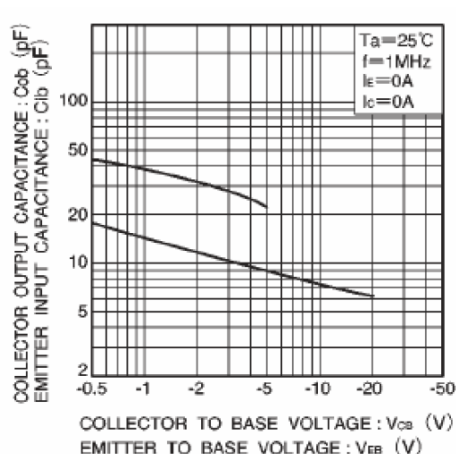

Fig.9 Collector output capacitance vs. collector-base voltage. Emitter input capacitance vs. emitter-base voltage