

RoHS Compliant Product
A suffix of "-C" specifies halogen and lead free

FEATURES

- Complementary NPN Type Available (MMBT3904-C)
- Epoxy Meets UL 94 V-0 Flammability Rating

SOT-23

APPLICATION

- General Switching and Amplification

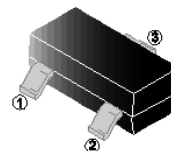

MARKING

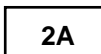
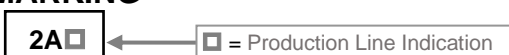

PACKAGE INFORMATION

Package	MPQ	Leader Size
SOT-23	3K	7 inch

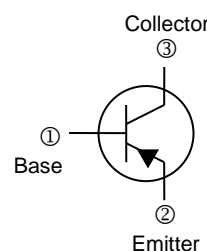

ORDER INFORMATION

Part Number	Type
MMBT3906-C	Lead (Pb)-free and Halogen-free

ABSOLUTE MAXIMUM RATINGS (T_J=25°C unless otherwise noted)

Parameter	Symbol	Ratings	Unit
Collector-Base Voltage	V _{CBO}	-40	V
Collector-Emitter Voltage	V _{CEO}	-40	
Emitter-Base Voltage	V _{EBO}	-5	
Collector Current-Continuous	I _C	-200	mA
Collector Power Dissipation ¹	P _C	225	mW
Thermal Resistance, Junction-Ambient	R _{θJA}	556	°C/W
Thermal Resistance, Junction-Case	R _{θJC}	488	
Operation Junction & Storage Temperature Range	T _J , T _{STG}	-55~150	°C

Note:

1. Device mounted on an FR4 PCB, single-sided copper, tin-plated and standard footprint.

ELECTRICAL CHARACTERISTICS ($T_J=25^{\circ}\text{C}$ unless otherwise noted)

Parameter	Symbol	Min.	TYP.	Max.	Unit	Test Conditions
Collector-Base Breakdown Voltage	$V_{(BR)CBO}$	-40	-	-	V	$I_C = -10\mu\text{A}, I_E = 0$
Collector-Emitter Breakdown Voltage	$V_{(BR)CEO}$	-40	-	-		$I_C = -1\text{mA}, I_B = 0$
Emitter-Base Breakdown Voltage	$V_{(BR)EBO}$	-5	-	-		$I_E = -10\mu\text{A}, I_C = 0$
Collector-Emitter Cut-off Current	I_{CEX}	-	-	-50	nA	$V_{CE} = -30\text{V}, V_{BE(off)} = -3\text{V}$
Collector-Base Cut-off Current	I_{CBO}	-	-	-100		$V_{CB} = -40\text{V}, I_E = 0$
Emitter-Base Cut-off Current	I_{EBO}	-	-	-100		$V_{EB} = -5\text{V}, I_C = 0$
DC Current Gain	h_{FE}	100	-	300		$I_C = -10\text{mA}, V_{CE} = -1\text{V}$
		60	-	-		$I_C = -50\text{mA}, V_{CE} = -1\text{V}$
		30	-	-		$I_C = -100\text{mA}, V_{CE} = -1\text{V}$
Collector-Emitter Saturation Voltage	$V_{CE(sat)}$	-	-	-0.25	V	$I_C = -10\text{mA}, I_B = -1\text{mA}$
		-	-	-0.4		$I_C = -50\text{mA}, I_B = -5\text{mA}$
Base-Emitter Saturation Voltage	$V_{BE(sat)}$	-0.65	-	-0.85		$I_C = -10\text{mA}, I_B = -1\text{mA}$
		-	-	-0.95		$I_C = -50\text{mA}, I_B = -5\text{mA}$
Transition Frequency	f_T	-	250	-	MHz	$I_C = -10\text{mA}, V_{CE} = -20\text{V}$ $f = 100\text{MHz}$
Output Capacitance	C_{obo}		4.5		PF	$V_{CB} = -5\text{V}, I_E = 0, f = 1\text{MHz}$
Input Capacitance	C_{ibo}		10		PF	$V_{BE} = -5\text{V}, I_C = 0, f = 1\text{MHz}$
Noise Figure	NF		4		dB	$I_C = -100\mu\text{A}, V_{CE} = -5\text{V}$ $R_S = 1\text{k}\Omega, f = 1\text{kHz}$
Delay Time	t_d	-	35	-	nS	$V_{CC} = -3\text{V}, V_{BE} = -0.5\text{V}$
Rise Time	t_r	-	35	-		$I_C = -10\text{mA}, I_{B1} = I_{B2} = -1\text{mA}$
Storage Time	t_s	-	225	-		$V_{CC} = -3\text{V}, I_C = -10\text{mA},$
Fall Time	t_f	-	75	-		$I_{B1} = I_{B2} = -1\text{mA}$

TYPICAL CHARACTERISTIC

Static Characteristics

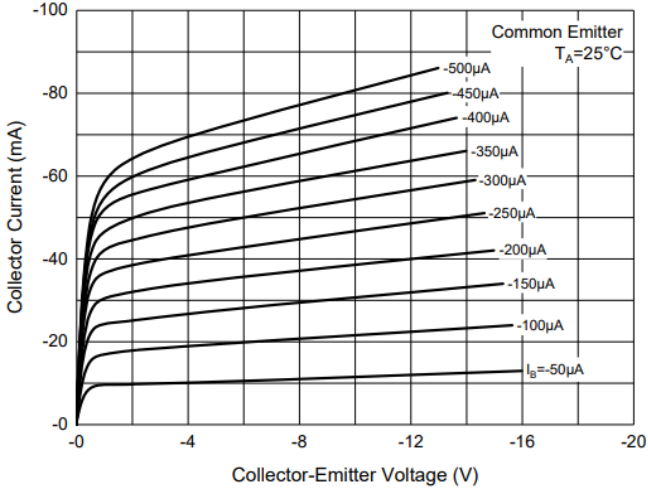

DC Current Gain Characteristics

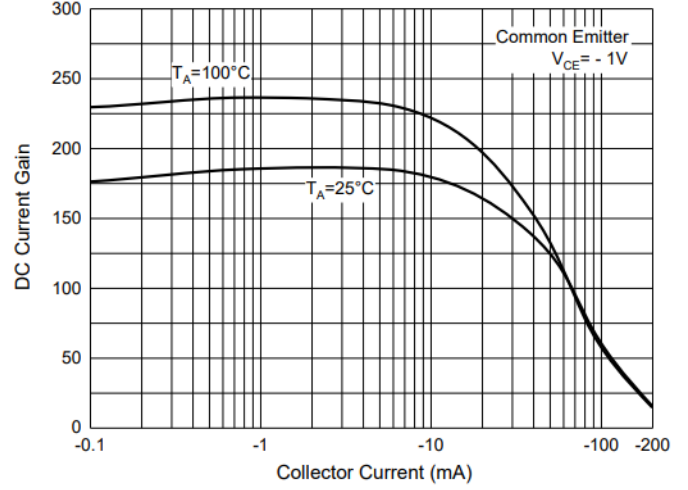

Collector-Emitter Saturation Voltage Characteristics

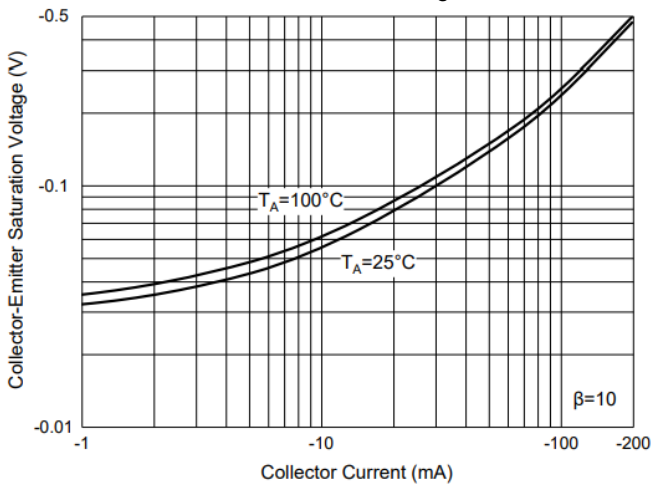

Base-Emitter Saturation Voltage Characteristics

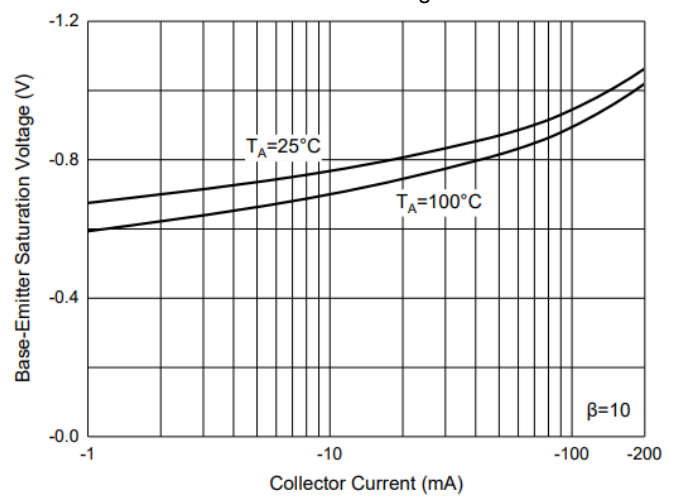

Base-Emitter Voltage Characteristics

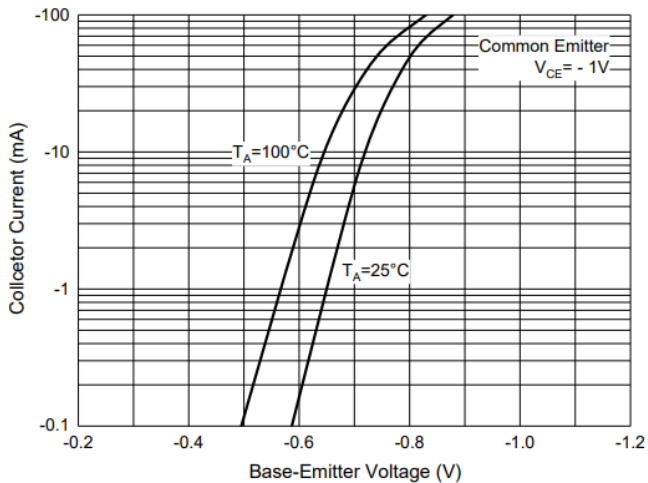

Collector Power Derating Curve

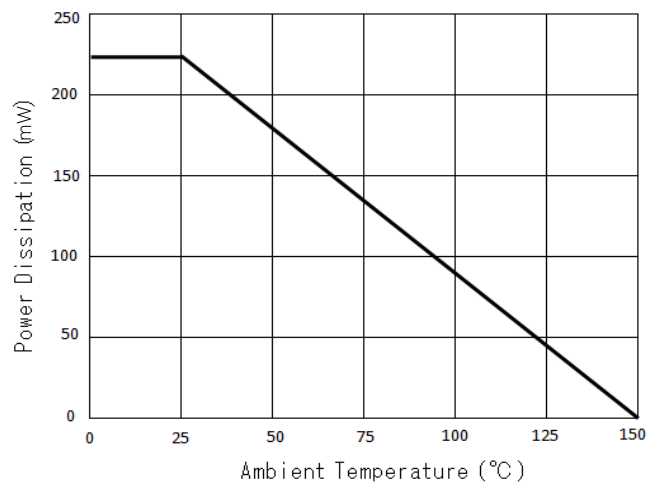

PACKAGE OUTLINE DIMENSIONS

SOT-23

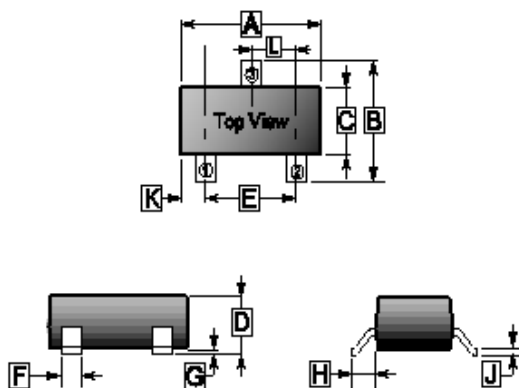

REF.	Millimeter	
	Min.	Max.
A	2.65	3.10
B	2.10	3.00
C	1.10	1.80
D	0.89	1.40
E	1.70	2.30
F	0.28	0.55
G	-	0.18
H	0.55 REF.	
J	0.05	0.26
K	0.60 REF.	
L	0.95 TYP.	

MOUNTING PAD LAYOUT

SOT-23

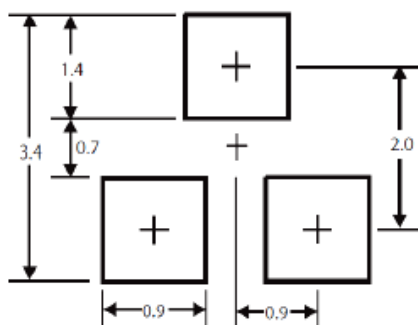

*Dimensions in millimeters