

RoHS Compliant Product
A suffix of "-C" specifies halogen and lead free

FEATURES

- Switching Transistor
- Qualified to AEC-Q101 Standards for High Reliability

SOT-23

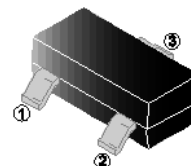

MARKING

2X

PACKAGE INFORMATION

Package	MPQ	Leader Size
SOT-23	3K	7 inch

ORDER INFORMATION

Part Number	Type
MMBT4401CR-C	Lead (Pb)-free and Halogen-free

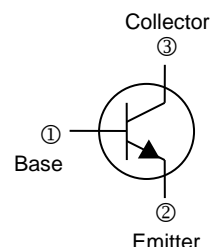

ABSOLUTE MAXIMUM RATINGS (T_J=25°C unless otherwise noted)

Parameter	Symbol	Ratings	Unit
Collector-Emitter Voltage	V _{CEO}	40	V
Collector-Base Voltage	V _{CBO}	60	V
Emitter-Base Voltage	V _{EBO}	6	V
Collector Continuous Current	I _C	600	mA
Collector Power Dissipation	P _D	300	mW
Thermal Resistance, Junction-Ambient	R _{θJA}	417	°C/W
Operating Junction & Storage Temperature Range	T _J , T _{STG}	-55~150	°C

ELECTRICAL CHARACTERISTICS ($T_J=25^{\circ}\text{C}$ unless otherwise noted)

Parameter	Symbol	Min.	Typ.	Max.	Unit	Test Conditions
Collector-Emitter Breakdown Voltage	$V_{(BR)CEO}$	40	-	-	V	$I_C=1\text{mA}, I_B=0$
Collector-Base Breakdown Voltage	$V_{(BR)CBO}$	60	-	-	V	$I_C=100\mu\text{A}, I_E=0$
Emitter-Base Breakdown Voltage	$V_{(BR)EBO}$	6	-	-	V	$I_E=100\mu\text{A}, I_C=0$
Collector-Base Cut-Off Current	I_{CBO}	-	-	0.1	μA	$V_{CB}=50\text{V}, I_E=0$
Collector-Emitter Cut-Off Current	I_{CEX}	-	-	0.1	μA	$V_{CE}=35\text{V}, V_{EB}=0.4\text{V}$
Emitter-Base Cut-Off Current	I_{EBO}	-	-	0.1	μA	$V_{EB}=5\text{V}, I_C=0$
DC Current Gain	h_{FE}	20	-	-		$I_C=0.1\text{mA}, V_{CE}=1\text{V}$
		40	-	-		$I_C=1\text{mA}, V_{CE}=1\text{V}$
		80	-	-		$I_C=10\text{mA}, V_{CE}=1\text{V}$
		100	-	300		$I_C=150\text{mA}, V_{CE}=1\text{V}$
		40	-	-		$I_C=500\text{mA}, V_{CE}=2\text{V}$
Collector-Emitter Saturation Voltage	$V_{CE(sat)}$	-	-	0.4	V	$I_C=150\text{mA}, I_B=15\text{mA}$
		-	-	0.75		$I_C=500\text{mA}, I_B=50\text{mA}$
Base-Emitter Saturation Voltage	$V_{BE(sat)}$	-	-	0.95	V	$I_C=150\text{mA}, I_B=15\text{mA}$
		-	-	1.2		$I_C=500\text{mA}, I_B=50\text{mA}$
Transition Frequency	f_T	250	-	-	MHz	$I_C=20\text{mA}, V_{CE}=10\text{V}, f=100\text{MHz}$
Delay Time	t_d	-	15	-	nS	$V_{CC}=30\text{V}, V_{BE}=2\text{V}$ $I_C=150\text{mA}, I_{B1}=15\text{mA}$
Rise Time	t_r	-	20	-		
Storage Time	t_s	-	225	-		
Fall Time	t_f	-	60	-		

TYPICAL CHARACTERISTIC

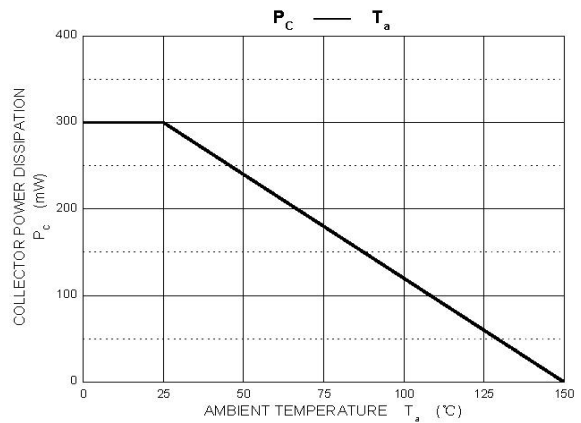
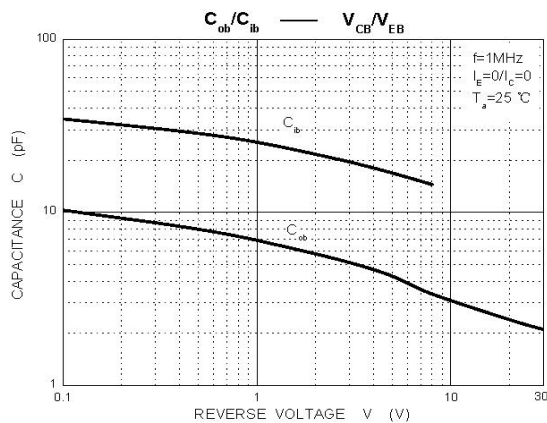
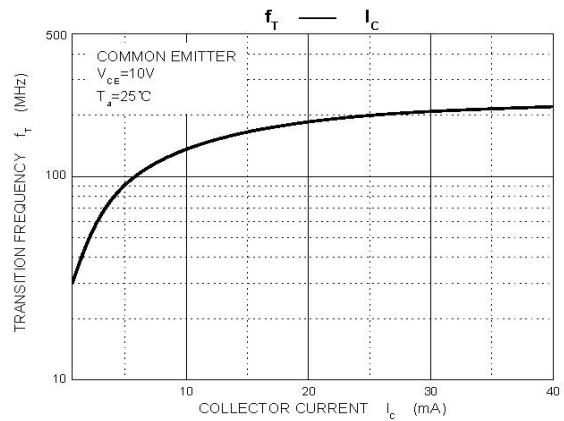
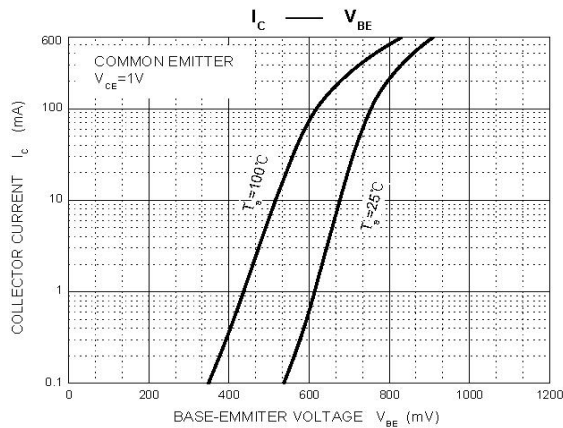
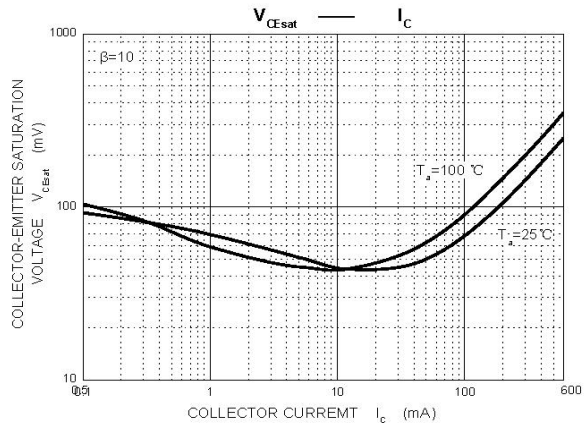
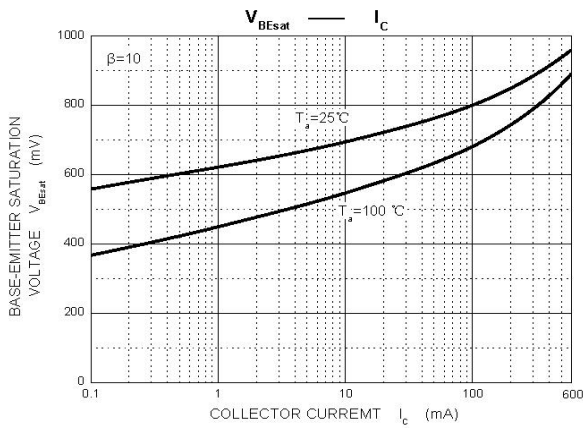
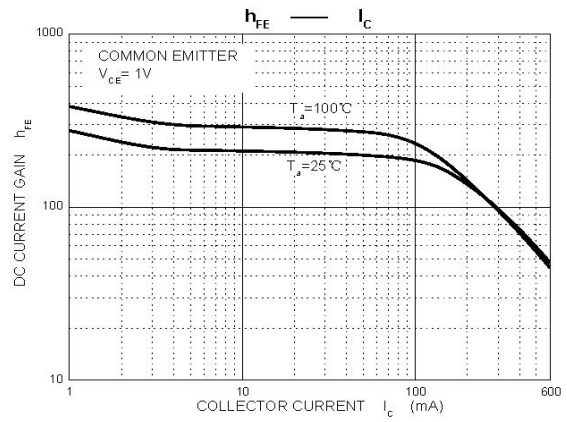
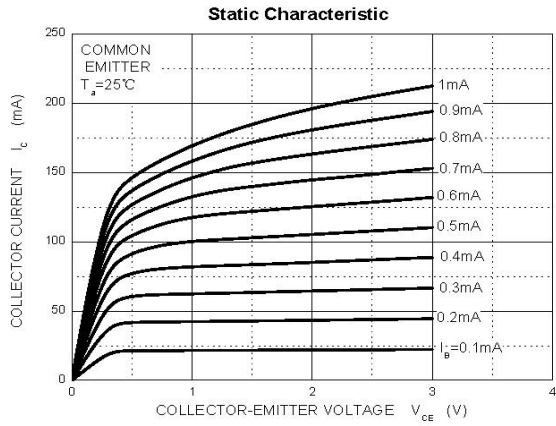

PACKAGE OUTLINE DIMENSIONS

SOT-23

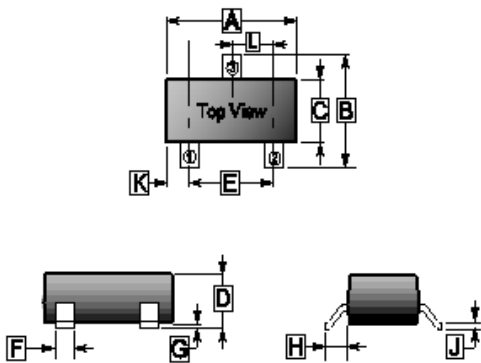

REF.	Millimeter	
	Min.	Max.
A	2.65	3.10
B	2.10	3.00
C	1.10	1.80
D	0.89	1.40
E	1.70	2.30
F	0.28	0.55
G	-	0.18
H	0.55 REF.	
J	0.05	0.26
K	0.60 REF.	
L	0.95 TYP.	

MOUNTING PAD LAYOUT

SOT-23

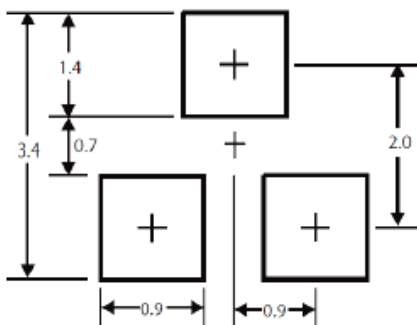

*Dimensions in millimeters