

RoHS Compliant Product
A suffix of "-C" indicates halogen-free.

FEATURE

- Epitaxial Die Construction

MARKING

BF

PACKAGE INFORMATION

Package	MPQ	Leader Size
SOT-363	3K	7 inch

SOT-363

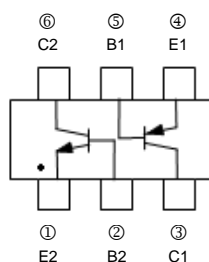
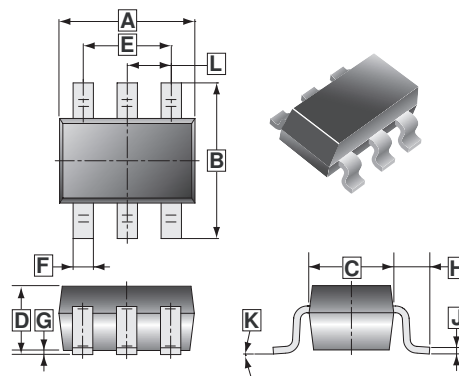

REF.	Millimeter		REF.	Millimeter	
	Min.	Max.		Min.	Max.
A	1.80	2.20	G	0.100	REF.
B	2.00	2.45	H	0.525	REF.
C	1.15	1.35	J	0.08	0.25
D	0.80	1.10	K	8°	
E	1.10	1.50	L	0.650	TYP.
F	0.10	0.35			

ABSOLUTE MAXIMUM RATINGS (T_A=25°C)

PARAMETER		SYMBOL	VALUE	UNITS
Collector to Base Voltage	NPN	V _{CBO}	50	V
	PNP		-50	
Collector to Emitter Voltage	NPN	V _{CEO}	45	V
	PNP		-45	
Emitter to Base Voltage	NPN	V _{EBO}	6	V
	PNP		-5	
Collector Current – Continuous	NPN	I _C	0.1	A
	PNP		-0.1	
Collector Power Dissipation	Per Device		380	mW
	FR-5 Board, T _A =25°C ¹		250	
	Derate Above 25°C		3	
Thermal Resistance, Junction to Ambient		R _{θJA}	328	°C/W
Junction Temperature		T _J	-55~150	°C
Storage Temperature		T _{STG}	-55~150	°C

Note:

1. FR-5 = 1.0 x 0.75 x 0.062 in

ELECTRICAL CHARACTERISTICS OF NPN ($T_A=25^\circ\text{C}$ unless otherwise noted)

CHARACTERISTIC	SYMBOL	MIN.	Min.	MAX.	UNIT	TEST CONDITION
Collector-Base Breakdown Voltage	$V_{(BR)CBO}$	50	-	-	V	$I_C=10\mu\text{A}$
Collector-Emitter Breakdown Voltage	$V_{(BR)CES}$	50	-	-	V	$I_C=10\mu\text{A}, V_{EB} = 0$
Collector-Emitter Breakdown Voltage	$V_{(BR)CEO}$	45	-	-	V	$I_C=10\text{mA}$
Emitter-Base Breakdown Voltage	$V_{(BR)EBO}$	6	-	-	V	$I_E=1\mu\text{A}$
Collector Cutoff Current	I_{CBO}	-	-	15	nA	$V_{CB}=30\text{V}$
		-	-	5	μA	$V_{CB}=30\text{V}, T_A=150^\circ\text{C}$
DC Current Gain	$h_{FE(1)}$	-	150	-		$V_{CE}=5\text{V}, I_C=10\mu\text{A}$
	$h_{FE(2)}$	200	290	475		$V_{CE}=5\text{V}, I_C=2\text{mA}$
Collector-emitter Saturation Voltage	$V_{CE(sat)}$	-	-	0.25	V	$I_C=10\text{mA}, I_B=0.5\text{mA}$
		-	-	0.6	V	$I_C=100\text{mA}, I_B=5\text{mA}$
Base-Emitter Saturation Voltage	$V_{BE(sat)}$	-	0.7	-	V	$I_C=10\text{mA}, I_B=0.5\text{mA}$
		-	0.9	-	V	$I_C=100\text{mA}, I_B=5\text{mA}$
Base-Emitter Voltage	$V_{BE(ON)}$	580	660	700	mV	$I_C=2\text{mA}, V_{CE} =5\text{V}$
		-	-	770		$I_C=10\text{mA}, V_{CE} =5\text{V}$
Transition Frequency	f_T	100	-	-	MHz	$V_{CE}=5\text{V}, I_C=10\text{mA}, f=100\text{MHz}$
Output Capacitance	C_{obo}	-	-	4.5	pF	$V_{CB}=10\text{V}, f=1\text{MHz}$
Noise Figure	NF	-	-	10	dB	$V_{CE}=5\text{V}, I_C=0.2\text{mA}, f=1\text{kHz}$ $R_S=2\text{K}\Omega, BW=200\text{Hz}$

ELECTRICAL CHARACTERISTICS OF PNP ($T_A=25^\circ\text{C}$ unless otherwise noted)

CHARACTERISTIC	SYMBOL	MIN.	Min.	MAX.	UNIT	TEST CONDITION
Collector-Base Breakdown Voltage	$V_{(BR)CBO}$	-50	-	-	V	$I_C = -10\mu\text{A}$
Collector-Emitter Breakdown Voltage	$V_{(BR)CES}$	-50	-	-	V	$I_C = -10\mu\text{A}, V_{EB} = 0$
Collector-Emitter Breakdown Voltage	$V_{(BR)CEO}$	-45	-	-	V	$I_C = -10\text{mA}$
Emitter-Base Breakdown Voltage	$V_{(BR)EBO}$	-5	-	-	V	$I_E = -1\mu\text{A}$
Collector Cutoff Current	I_{CBO}	-	-	-15	nA	$V_{CB} = -30\text{V}$
		-	-	-4	μA	$V_{CB} = -30\text{V}, T_A = 150^\circ\text{C}$
DC Current Gain	$h_{FE(1)}$	-	150	-		$V_{CE} = -5\text{V}, I_C = -10\mu\text{A}$
	$h_{FE(2)}$	200	290	475		$V_{CE} = -5\text{V}, I_C = -2\text{mA}$
Collector-emitter Saturation Voltage	$V_{CE(sat)}$	-	-	-0.3	V	$I_C = -10\text{mA}, I_B = -0.5\text{mA}$
		-	-	-0.65	V	$I_C = -100\text{mA}, I_B = -5\text{mA}$
Base-Emitter Saturation Voltage	$V_{BE(sat)}$	-	-0.7	-	V	$I_C = -10\text{mA}, I_B = -0.5\text{mA}$
		-	-0.9	-	V	$I_C = -100\text{mA}, I_B = -5\text{mA}$
Base-Emitter Voltage	$V_{BE(ON)}$	-600	-	-750	mV	$I_C = -2\text{mA}, V_{CE} = -5\text{V}$
		-	-	-820		$I_C = -10\text{mA}, V_{CE} = -5\text{V}$
Transition Frequency	f_T	100	-	-	MHz	$V_{CE} = -5\text{V}, I_C = -10\text{mA}, f = 100\text{MHz}$
Output Capacitance	C_{obo}	-	-	4.5	pF	$V_{CB} = -10\text{V}, f = 1\text{MHz}$
Noise Figure	NF	-	-	10	dB	$V_{CE} = -5\text{V}, I_C = -0.2\text{mA}, f = 1\text{kHz}, R_S = 2\text{K}\Omega, BW = 200\text{Hz}$

CHARACTERISTIC CURVES

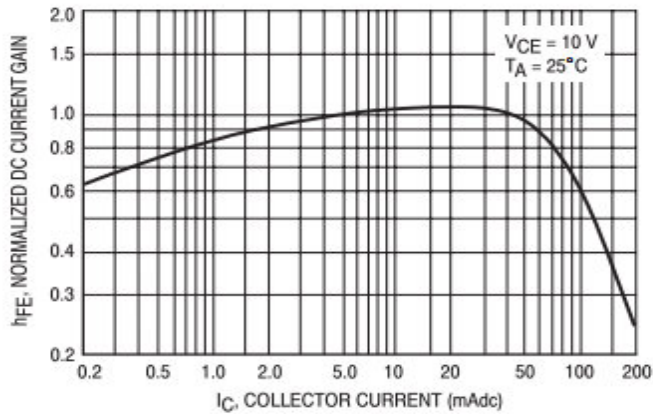

Figure 1. Normalized DC Current Gain

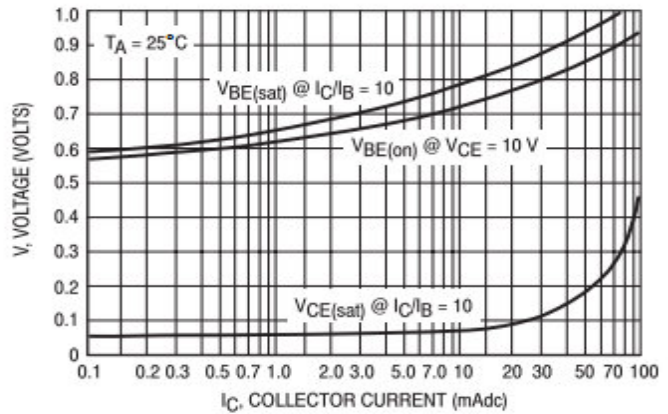

Figure 2. "Saturation" and "On" Voltages

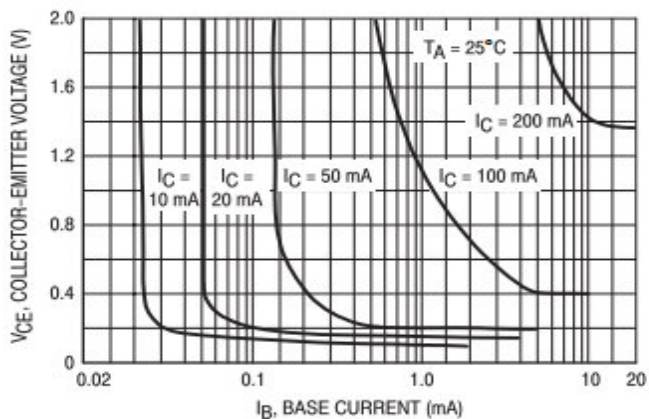

Figure 3. Collector Saturation Region

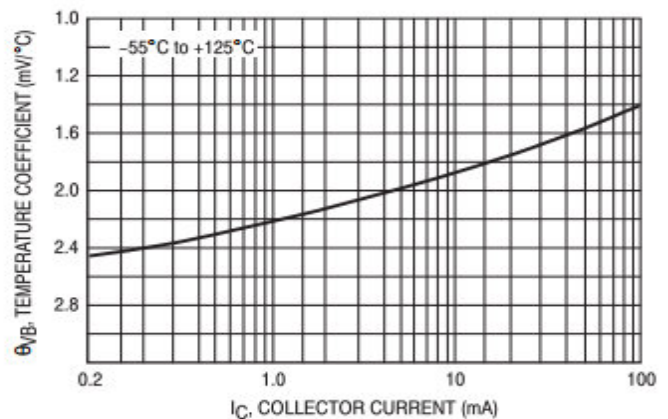

Figure 4. Base-Emitter Temperature Coefficient

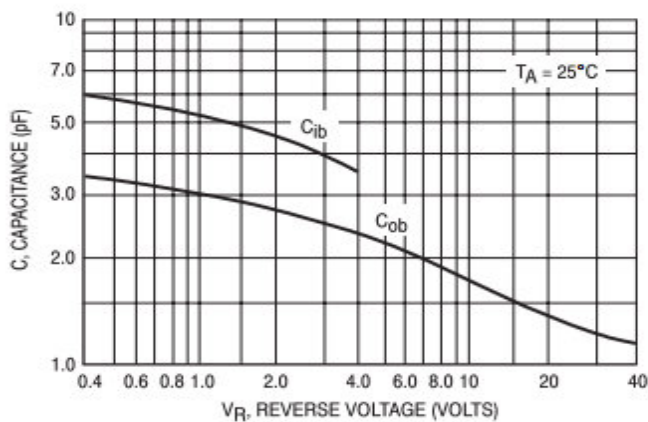

Figure 5. Capacitances

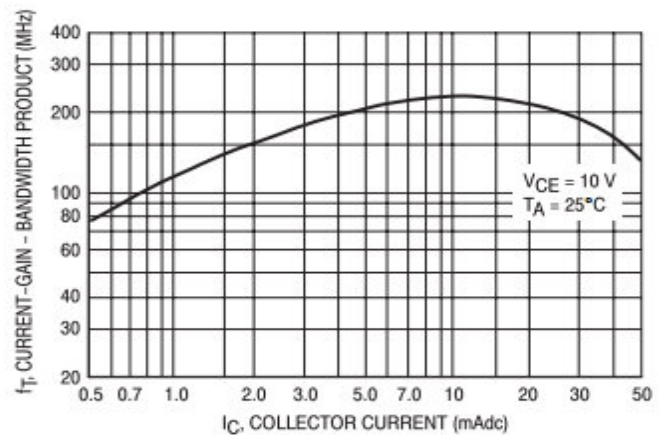

Figure 6. Current-Gain - Bandwidth Product

CHARACTERISTIC CURVES

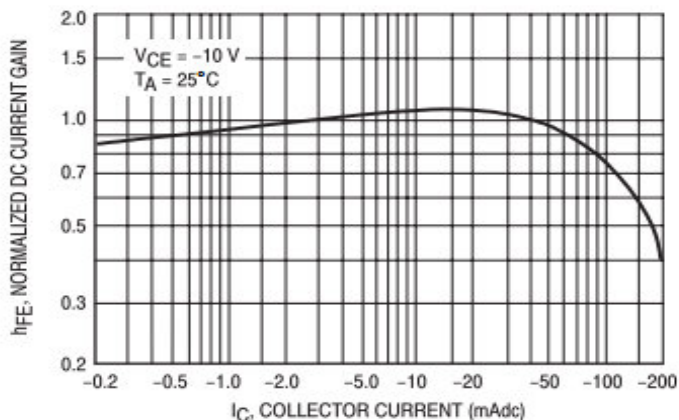

Figure 7. Normalized DC Current Gain

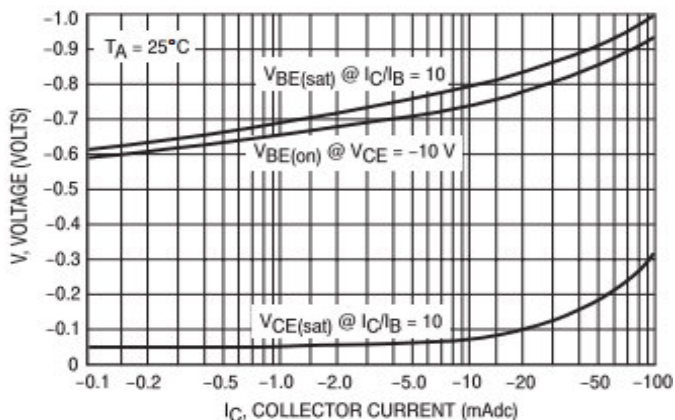

Figure 8. "Saturation" and "On" Voltages

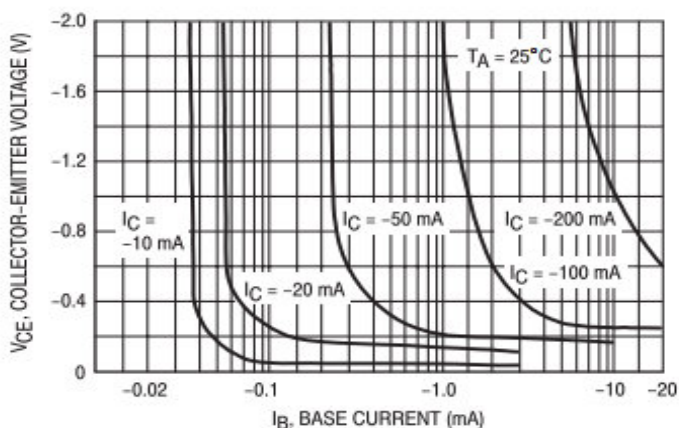

Figure 9. Collector Saturation Region

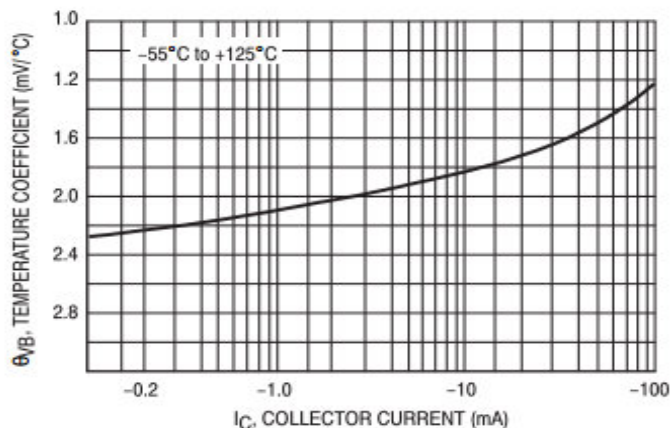

Figure 10. Base-Emitter Temperature Coefficient

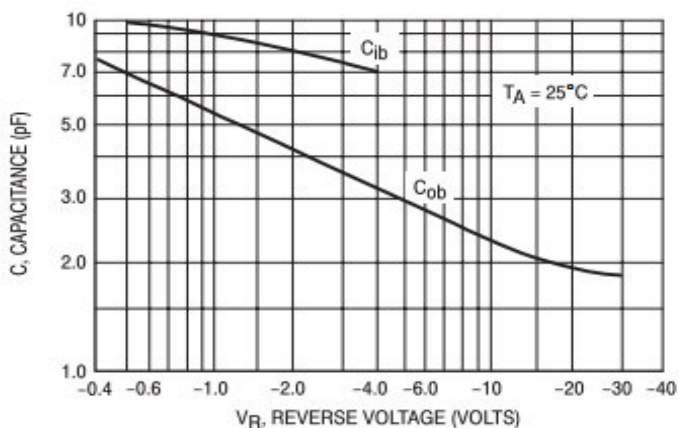

Figure 11. Capacitances

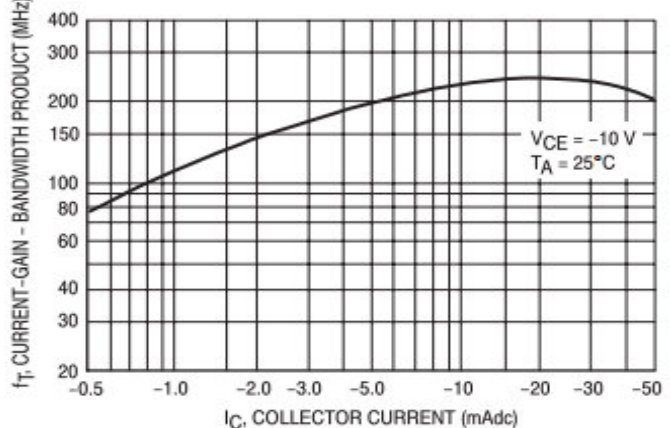

Figure 12. Current-Gain - Bandwidth Product

CHARACTERISTIC CURVES

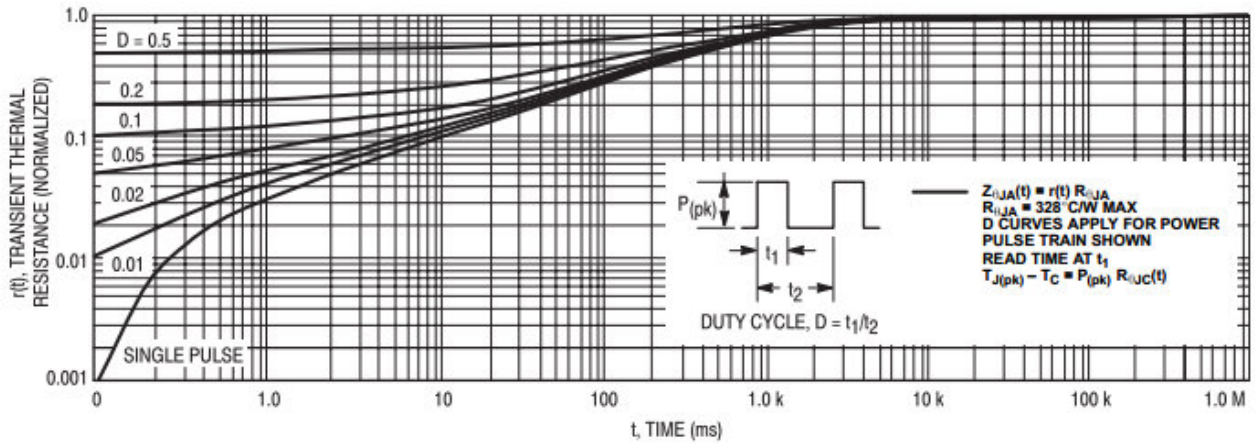

Figure 13. Thermal Response