

RoHS Compliant Product
A suffix of "-C" specifies halogen & lead-free

FEATURES

- Audio amplifier
- Flagg unit of camera
- Switching circuit

CLASSIFICATION OF $h_{FE(2)}$

Rank	Q	R	S
Range	230 - 380	340 - 600	560 - 800

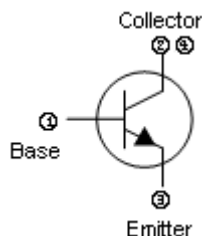

SOT-89

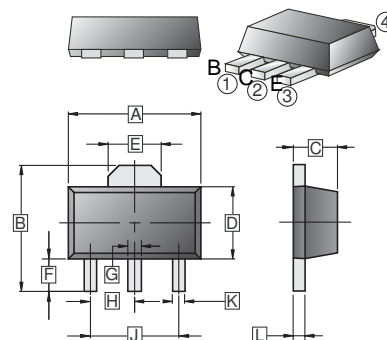

REF.	Millimeter		REF.	Millimeter	
	Min.	Max.		Min.	Max.
A	4.40	4.60	G	0.40	0.58
B	3.94	4.25	H	1.50	TYP
C	1.40	1.60	J	3.00	TYP
D	2.30	2.60	K	0.32	0.52
E	1.50	1.70	L	0.35	0.44
F	0.89	1.20			

ABSOLUTE MAXIMUM RATINGS ($T_A=25^\circ\text{C}$ unless otherwise specified)

Parameter	Symbol	Rating	Unit
Collector-Base Voltage	V_{CB0}	40	V
Collector-Emitter Voltage	V_{CEO}	30	V
Emitter-Base Voltage	V_{EBO}	7	V
Collector Current-Continuous	I_C	5	A
Collector Power Dissipation	P_C	750	mW
Junction & Storage Temperature	T_J, T_{STG}	150, -55~150	$^\circ\text{C}$

ELECTRICAL CHARACTERISTICS ($T_A=25^\circ\text{C}$ unless otherwise specified)

Parameter	Symbol	Min.	Typ.	Max.	Unit	Test Condition
Collector-Base breakdown voltage	$V_{(BR)CB0}$	40	-	-	V	$I_C=0.1\text{mA}, I_E=0$
Collector-Emitter Breakdown Voltage	$V_{(BR)CEO}$	30	-	-	V	$I_C=1\text{mA}, I_B=0$
Emitter-Base Breakdown voltage	$V_{(BR)EBO}$	7	-	-	V	$I_E=10\mu\text{A}, I_C=0$
Collector Cut-Off Current	I_{CB0}	-	-	0.1	μA	$V_{CB}=10\text{V}, I_E=0$
Emitter Cut-Off Current	I_{EBO}	-	-	0.1	μA	$V_{EB}=7\text{V}, I_C=0$
DC Current Gain	$h_{FE(1)}$	-	200	-		$V_{CE}=2\text{V}, I_C=1\text{mA}$
	$h_{FE(2)}$	230	-	800		$V_{CE}=2\text{V}, I_C=500\text{mA}$
	$h_{FE(3)}$	150	-	-		$V_{CE}=2\text{V}, I_C=2\text{A}$
Collector-Emitter Saturation Voltage	$V_{CE(sat)}$	-	-	1	V	$I_C=3\text{A}, I_B=0.1\text{A}$
Transition Frequency	f_T	-	150	-	MHz	$V_{CE}=6\text{V}, I_C=50\text{mA}$
Output Capacitance	C_{OB}	-	-	50	pF	$V_{CB}=20\text{V}, I_E=0, f=1\text{MHz}$

CHARACTERISTIC CURVES

Fig.1 Static characteristics

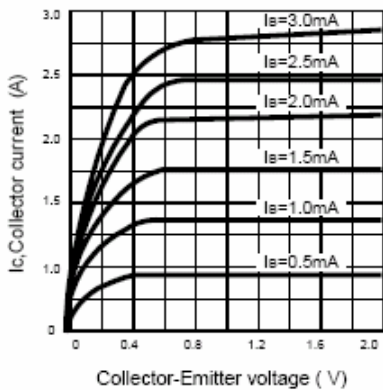

Fig.2 DC current Gain

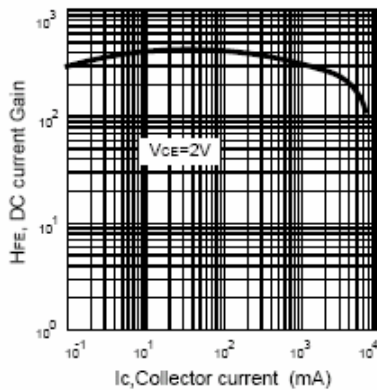

Fig.3 Base-Emitter on Voltage

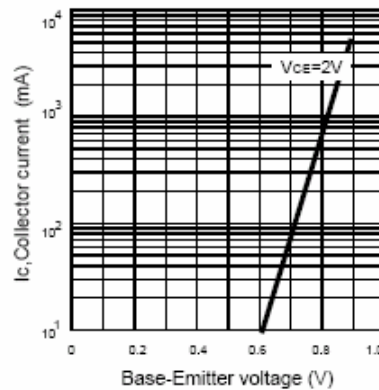

Fig.4 Saturation voltage

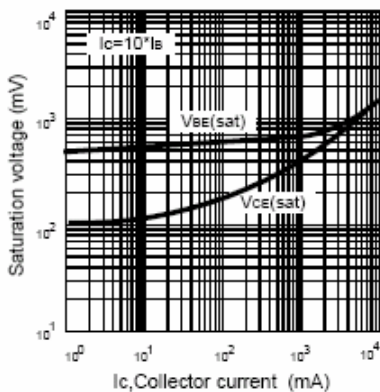

Fig.5 Current gain-bandwidth product

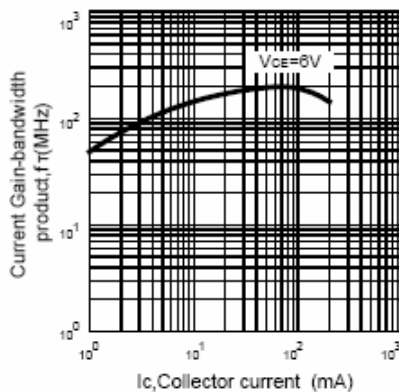

Fig.6 Collector output Capacitance

