

RoHS Compliant Product

A suffix of "-C" specifies halogen & lead-free

FEATURES

- Plastic package has underwriters laboratory Flammability classification 94V-0
Flame retardant epoxy molding compound
- Metal silicon junction, majority carrier conduction
- Low power loss, high efficiency
- High current capability

MECHANICAL DATA

- Case: TO-252(D-Pack) Molded plastic
- Terminals: Solder plated, solderable per MIL-STD-750, Method 2026
- Polarity: As Marked
- Mounting position: Any

TO-252(D-PACK)

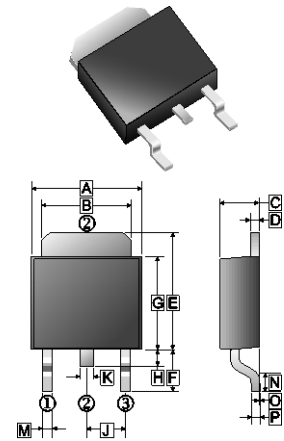

PACKAGE INFORMATION

Package	MPQ	Leader Size
TO-252	2.5K	13 inch

REF.	Millimeter		REF.	Millimeter	
	Min.	Max.		Min.	Max.
A	6.35	6.9	J	2.3	REF.
B	4.95	5.53	K	0.89	REF.
C	2.1	2.5	M	0.45	1.14
D	0.41	0.9	N	1.55	Typ.
E	6	7.5	O	0	0.13
F	2.90	REF.	P	0.58	REF.
G	5.4	6.4			
H	0.6	1.2			

ORDER INFORMATION

Part Number	Type
MBR1040D1-C~MBR10200D1-C	Lead (Pb)-free and Halogen-free

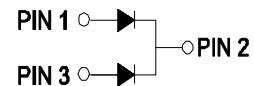

MAXIMUM RATINGS AND ELECTRICAL CHARACTERISTICS

(Rating 25°C ambient temperature unless otherwise specified. Single phase half wave, 60Hz, resistive or inductive load.

For capacitive load, de-rate current by 20%.)

Parameter	Symbol	Part Number					Unit
		MBR 1040D1-C	MBR 1060D1-C	MBR 10100D1-C	MBR 10150D1-C	MBR 10200D1-C	
Maximum Recurrent Peak Reverse Voltage	V_{RRM}	40	60	100	150	200	V
Maximum RMS Voltage	V_{RMS}	28	42	70	105	140	V
Maximum DC Blocking Voltage	V_{DC}	40	60	100	150	200	V
Maximum Average Forward Current see fig.1	$I_{F(AV)}$	10					A
Peak Forward Surge Current, 8.3ms single half sine-wave superimposed on rated load(JEDEC method)	I_{FSM}	100					A
Maximum Forward Voltage @5A per leg	V_F	0.7	0.8	0.85	0.92		V
Maximum DC Reverse Current at Rated DC Blocking Voltage	$T_J=25^\circ\text{C}$	0.05					mA
	$T_J=125^\circ\text{C}$	20					
Typical Thermal Resistance	$R_{\theta JC}$	10					°C/W
Operating & Storage Temperature	T_J, T_{STG}	-55~150					°C

RATINGS AND CHARACTERISTIC CURVES

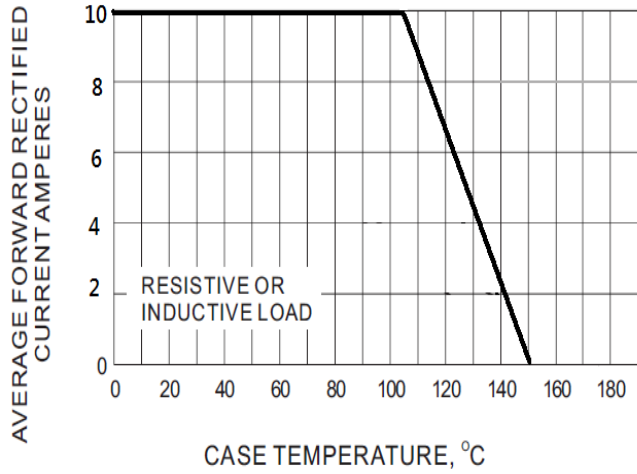

Fig.1- FORWARD CURRENT DERATING CURVE

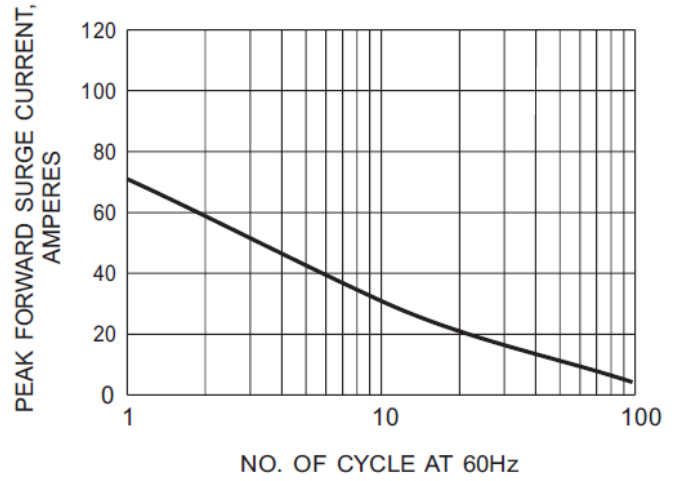

Fig.2- MAXIMUM NON - REPETITIVE FORWARD SURGE CURRENT

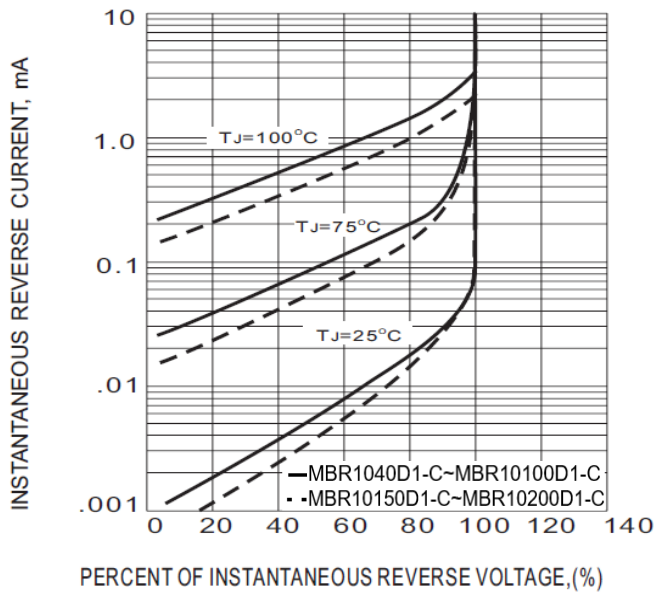

Fig.3- TYPICAL REVERSE CHARACTERISTICS

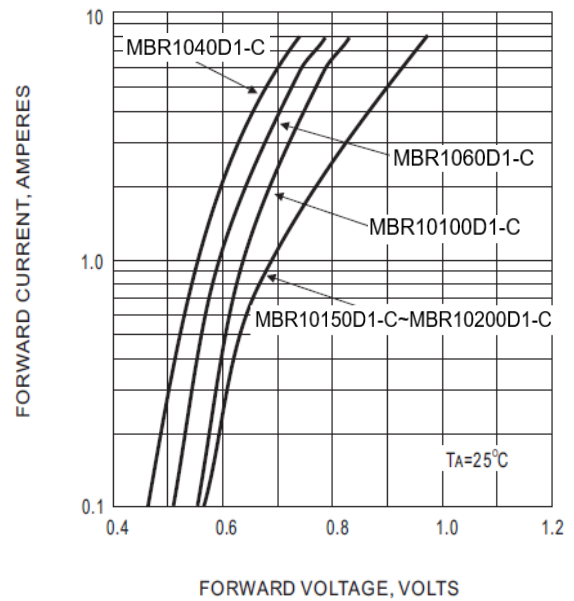

Fig.4- TYPICAL INSTANTANEOUS FORWARD CHARACTERISTIC

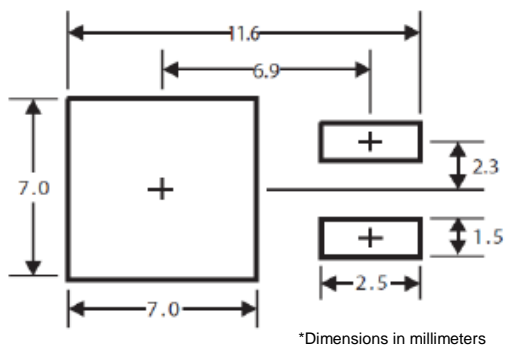

Fig.5- MOUNTING PAD LAYOUT