

RoHS Compliant Product  
 A suffix of "-C" specifies halogen and lead-free

**DESCRIPTION**

Designed to protect voltage sensitive electronic components from ESD and other transients. Excellent clamping capability, low leakage, low capacitance, and fast response time provide best in class protection on designs that are exposed to ESD.

The combination of small size, low capacitance, and high level of ESD protection makes them a flexible solution for applications such as HDMI, Display Port TM, and MDDI interfaces. It is designed to replace multi-layer varistors (MLV) in consumer equipments applications such as mobile phone, notebook, PAD, STB, LCD TV etc.

**SOD-523**

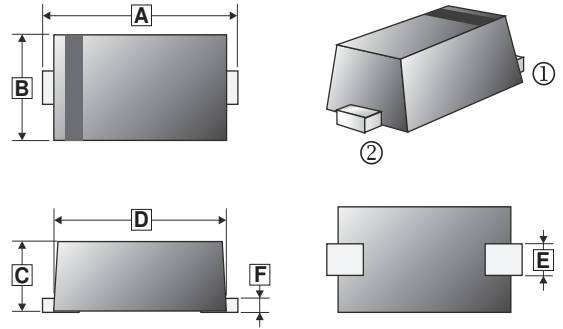

REF.	Millimeter		REF.	Millimeter	
	Min.	Max.		Min.	Max.
A	1.50	1.70	D	1.10	1.30
B	0.70	0.90	E	0.25	0.35
C	0.50	0.77	F	0.07	0.20

**FEATURES**

- Uni-directional ESD protection of one line
- Reverse stand-off voltage
- Low reverse clamping voltage
- Low leakage current
- Excellent package: 1.2mm×0.8mm×0.6mm
- Fast response time
- JESD22-A114-B ESD Rating of class 3B per human body model
- IEC 61000-4-2 Level 3 ESD protection



**MARKING**



**PACKAGE INFORMATION**

Package	MPQ	Leader Size
SOD-523	8K	7 inch

**ORDER INFORMATION**

Part Number	Type
ESD15	Lead (Pb)-free
ESD15-C	Lead (Pb)-free and Halogen-free

**ABSOLUTE MAXIMUM RATINGS** (T<sub>A</sub>=25°C unless otherwise specified)

Parameter	Symbol	Limit	Unit
IEC 61000-4-2 ESD Voltage <sup>1</sup>	V <sub>ESD</sub>	±25	kV
		±25	
		±16	
		±0.4	
JESD22-A114-B ESD Voltage <sup>1</sup>	Per Human Body Model	±16	
ESD Voltage <sup>1</sup>	Machine Model	±0.4	
Peak Pulse Power <sup>2</sup>	P <sub>PP</sub>	323	W
Peak Pulse Current <sup>2</sup>	I <sub>PP</sub>	9.5	A
Maximum Lead Solder Temperature @10 Second Duration	T <sub>L</sub>	260	°C
Junction & Storage temperature Range	T <sub>J</sub> , T <sub>STG</sub>	150, -55~150	°C

**ELECTRICAL CHARACTERISTICS** ( $T_A=25^\circ\text{C}$  unless otherwise specified)

Parameter	Symbol	Min.	Typ.	Max.	Unit	Test Conditions
Reverse Stand-off Voltage	$V_{RWM}$	-	-	15	V	
Breakdown Voltage	$V_{(BR)}$	16.7	-	20	V	$I_T=1\text{mA}$
Clamping Voltage <sup>2</sup>	$V_C$	-	-	34	V	$I_{PP}=9.5\text{A}$
Forward voltage	$V_F$	-	-	0.9	V	$I_F=10\text{mA}$
Reverse Leakage Current	$I_R$	-	-	1	$\mu\text{A}$	$V_{RWM}=15\text{V}$
Junction Capacitance	$C_J$	-	48	-	pF	$V_R=0\text{V}$ , $f=1\text{MHz}$

Notes:

1. Device stressed with ten non-repetitive ESD pulses.
2. Non-repetitive current pulse 8/20 $\mu\text{s}$  exponential decay waveform according to IEC61000-4-5.

**ESD standards compliance**

**IEC61000-4-2 Standard**

Contact Discharge		Air Discharge	
Level	Test Voltage kV	Level	Test Voltage kV
1	2	1	2
2	4	2	4
3	6	3	8
4	8	4	15

**JESD22-A114-B Standard**

ESD Class	Human Body Discharge V
0	0~249
1A	250~499
1B	500~999
1C	1000~1999
2	2000~3999
3A	4000~7999
3B	8000~15999

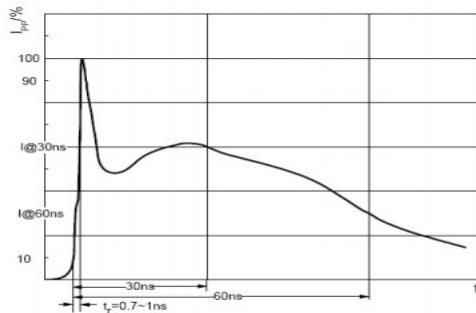

ESD pulse waveform according to IEC61000-4-2

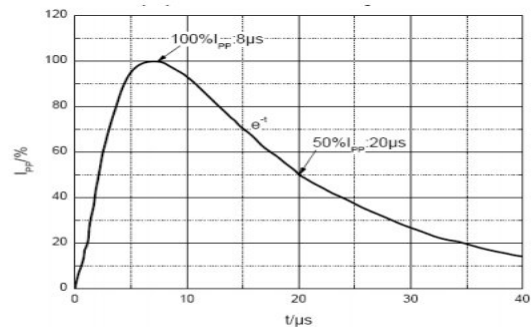

8/20 $\mu\text{s}$  pulse waveform according to IEC 61000-4-5

**ELECTRICAL PARAMETER**

Symbol	Parameter
$V_C$	Clamping Voltage @ $I_{PP}$
$I_{PP}$	Peak Pulse Current
$V_{BR}$	Breakdown Voltage @ $I_T$
$I_T$	Test Current
$I_R$	Reverse Leakage Current @ $V_{RWM}$
$V_{RWM}$	Reverse Standoff Voltage
$V_F$	Forward Voltage @ $I_F$
$I_F$	Forward Current

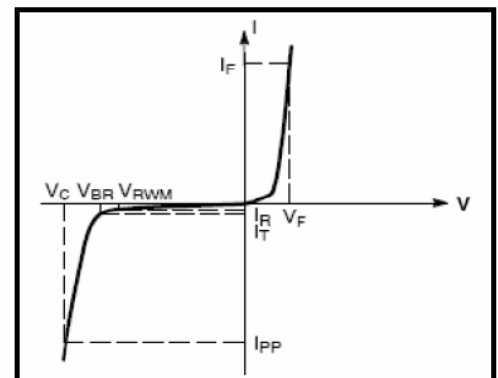

V-I characteristics for a uni-directional TVS

**RATINGS AND CHARACTERISTICS CURVES**

**Forward Characteristics**

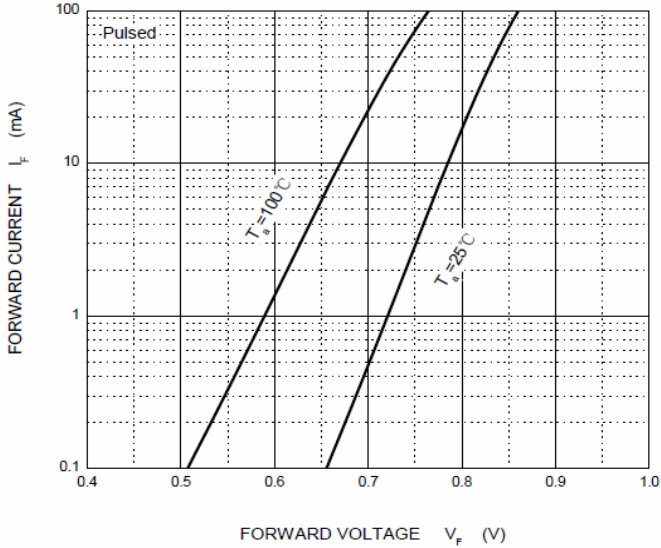

**Reverse Characteristics**

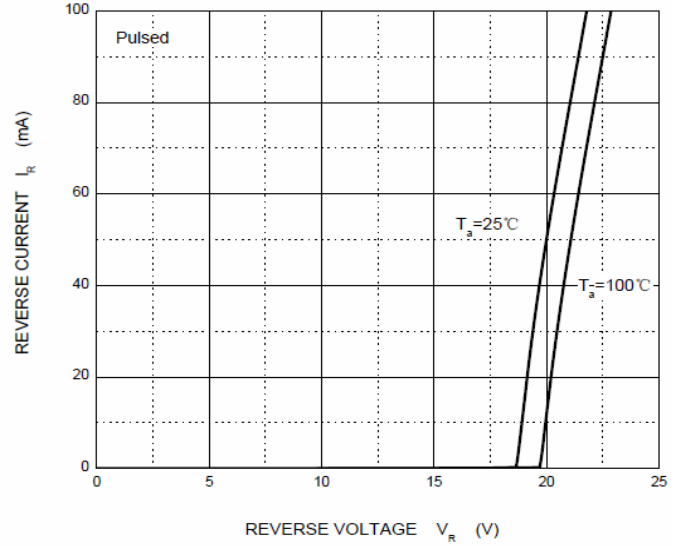

$V_C$  —  $I_{PP}$

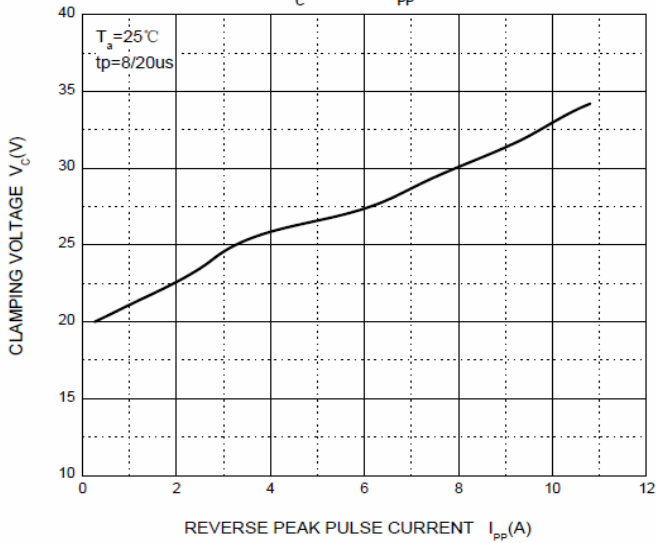

**Capacitance Characteristics**

