

RoHS Compliant Product

## FEATURES

- Surface mount bridge, small package
- Ideal for printed circuit boards
- Glass passivated chip junction
- High forward current capability up to 5A
- High heat dissipation capability
- Low forward voltage drop
- Plastic package has Underwrites Laboratory Flammability Classification 94V-0

## MECHANICAL DATA

- Case: HBS
- Terminals: Matte tin plated leads, solderable per J-STD-002 and JESD22-B102
- High temperature soldering guaranteed: Solder Reflow 260°C, 10seconds
- Polarity: As marked on body

## PACKAGE INFORMATION

Package	MPQ	Leader Size
HBS	2.5K	13 inch

## ORDER INFORMATION

Part Number	Type
RHBS502H-RHBS510H	Lead (Pb)-free and Halogen-free

## MAXIMUM RATINGS AND ELECTRICAL CHARACTERISTICS

(Rating at 25°C ambient temperature unless otherwise specified. Single phase half wave, 60Hz, resistive or inductive load.  
For capacitive load, de-rate current by 20%.)

Parameter	Symbol	Part Number					Unit
		RHBS502H	RHBS504H	RHBS506H	RHBS508H	RHBS510H	
Maximum Peak Repetitive Reverse Voltage	$V_{RRM}$	200	400	600	800	1000	V
Maximum RMS Voltage	$V_{RMS}$	140	280	420	560	700	
Maximum DC Blocking Voltage	$V_{DC}$	200	400	600	800	1000	
Average Rectified Output Current <sup>2</sup>	$I_F$	5					A
Non-Repetitive Peak Forward Surge Current @8.3ms Single half sine-wave Superimposed on rated load	$I_{FSM}$	150					A
Rating for Fusing (t<8.3ms)	$I^2t$	93.3					A <sup>2</sup> s
Instantaneous Forward Voltage Drop Per Diode	$V_F$	$I_F=1A$	0.92				V
		$I_F=2.5A$	1				
		$I_F=5A$	1.07				
Peak Reverse Current @Rated DC Blocking Voltage	$I_R$	$T_A=25^\circ C$	5				$\mu A$
		$T_A=125^\circ C$	100				
Typical Junction Capacitance <sup>1</sup>	$C_J$	35					pF
Maximum Reverse Recovery Time @ $I_F=0.5A, I_R=1.0A, I_{rr}=0.25A$	$T_{rr}$	150		250	500		nS
Thermal Resistance <sup>2</sup>	$R_{\theta JA}$	72					$^\circ C/W$
	$R_{\theta JC}$	23					
Operating & Storage Temperature Range	$T_J, T_{STG}$	-55~150					$^\circ C$

Notes:

1. Measured at 1MHz and applied reverse voltage of 5.0V D.C.
2. Device mounted on 20mm x 20mm x 1.6mm AL pad, attached on 100mm x 80mm x 30mm Fin heat sink.

## HBS

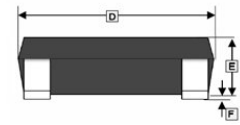
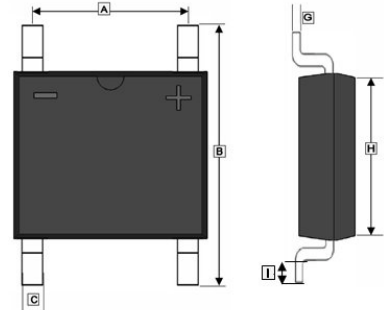

	Millimeter		REF.	Millimeter	
	Min.	Max.		Min.	Max.
A	5.25	5.60	F	-	0.2
B	9.75	10.05	G	0.15	0.35
C	1.70	1.90	H	6.85	7.15
D	10.05	10.35	I	0.45	0.95
E	1.45	1.65			

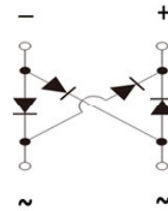

**RATINGS AND CHARACTERISTIC CURVES**

**FIG.1 Derating Curve Output Rectified Current**

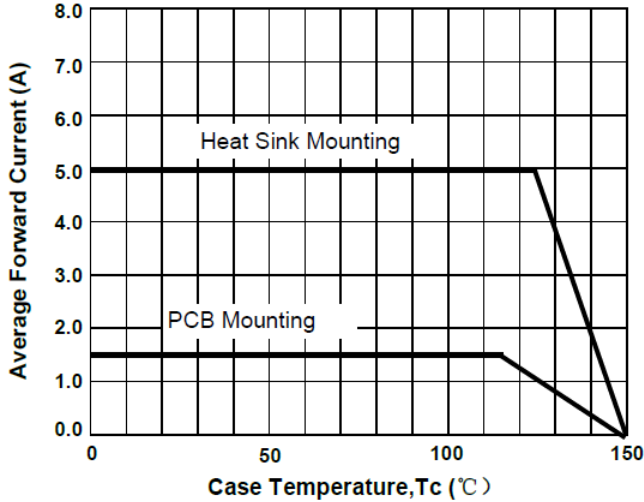

**FIG.2 Typical Forward Characteristics per Diode**

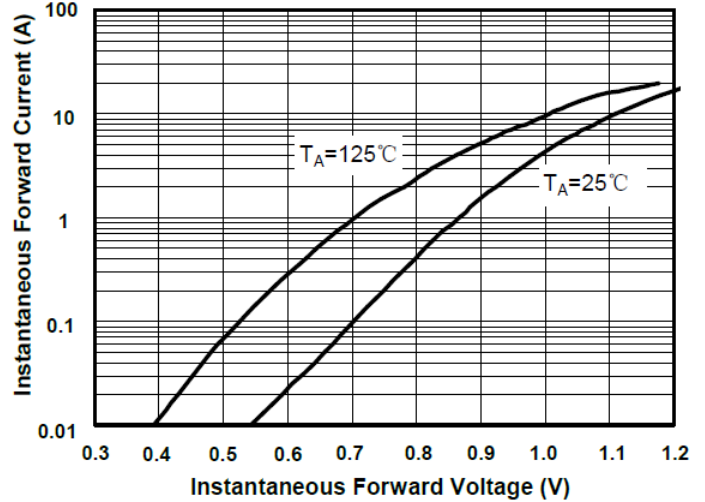

**FIG.3 Maximum Non-Repetitive Peak Forward Surge Current per Diode**

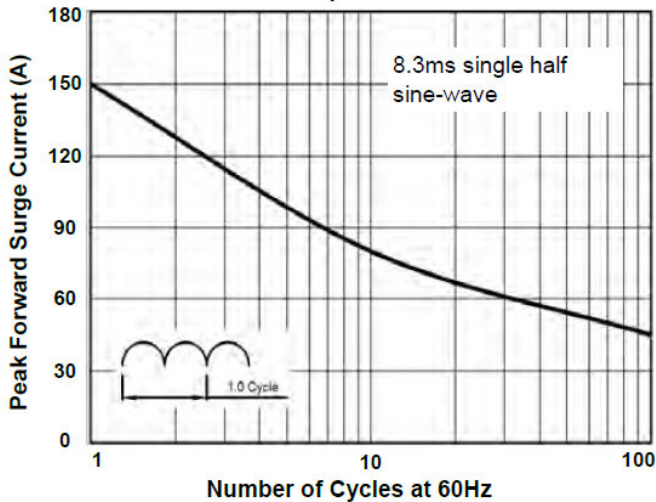

**FIG.4 Typical Reverse Characteristics per Diode**

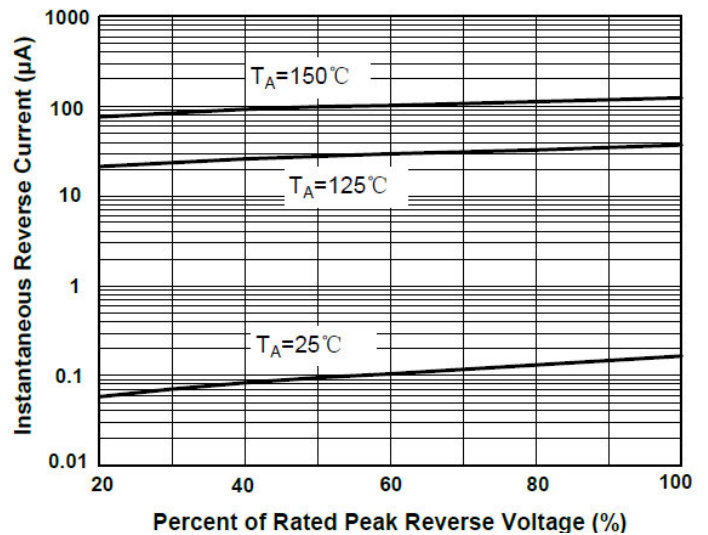

**FIG.5 Typical Junction Capacitance per Diode**

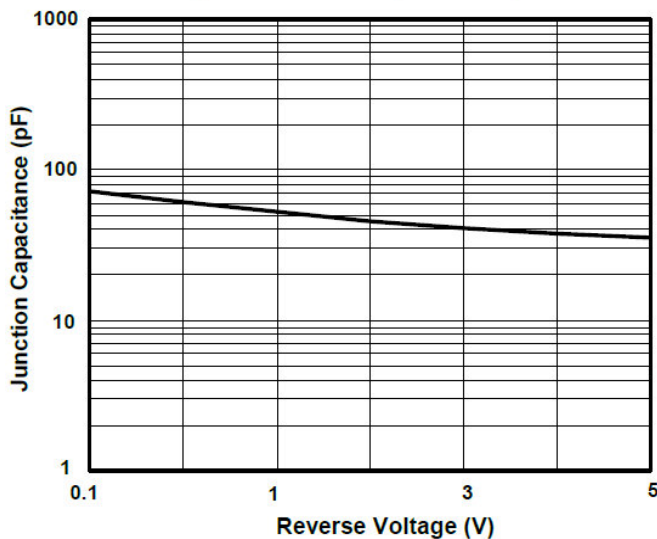

**Suggested PCB printfoot layout**

